

INTRODUCTION TO AEROSPACE ENGINEERING

BY

Ms. G. Sravanthi
Assistant Professor

Mr. R. Suresh kumar
Assistant Professor



INSTITUTE OF AERONAUTICAL ENGINEERING

(Autonomous)

Dundigal, Hyderabad - 500 043

AERONAUTICAL ENGINEERING

Early Flight to World War I

Overview

- Early Uses of Lighter-than-Air Flying Machines
- Heavier-than-Air Flying Machines
 - The US Army's Reaction to the Wright Brothers' Invention
 - The Army's Requirements for the First Military Aircraft
- Early Uses of Airpower

Early Years of Flight Introduction

- Man first flew aloft in a balloon in 1783
- Airpower did not have an immediate impact
- Flying machines were not readily accepted by land oriented officers
- Airpower's first major impact was not until World War I

Balloons

- Mongolier Brothers flew first hot-air balloon in 1783
- Ben Franklin saw first balloon flight and immediately saw the military potential
- First used for military purposes by the French in 1794 at Maubege
- Union and Confederate forces employed balloons during the American Civil War

Balloons (Cont)

- Adolphus V. Greely, the grandfather of military aviation in US, revived interest in military capability of balloons in 1891
 - 1892 -- Greely balloon used to direct artillery fire during the Battle of San Juan Hill
- Interest in balloons dropped quickly with the development of heavier-than-air vehicles

Dirigibles

- Steerable balloons -- often called “Airships”
- 1884 -- first successful flight in a dirigible
- Ferdinand Von Zeppelin -- person most readily identified with dirigibles
 - Zeppelins first flown in 1900
 - Germans used to bomb England in WW I
 - Germans used to fly observation cover for their surface fleet in WW I
- Vulnerable to winds and ground fire

The Early Years of Flight

- Uses of Balloons and Dirigibles
 - Reconnaissance
 - Artillery spotting
 - Bombing (extremely limited prior to WW I)
 - Morale Booster/Mail/Escape Means
 - Air transport of supplies

Early Pioneers of Flight

- Otto Lilienthal -- studied gliders and first to explain the superiority of curved surfaces
- Percy Pilcher -- built airplane chassis
- Octave Chanute -- Developed a double winged-glider/wrote history of flight to 1900
- Samuel P. Langley -- First to secure government support to develop an airplane
 - Failed twice to fly from houseboat in 1903
 - Congress withdrew monetary support

Orville and Wilbur Wright

- First to fly a heavier-than-air, power-driven machine -- 17 December 1903
 - Flight traveled 120 feet and lasted 12 seconds
- Approached flying scientifically and systematically
- Used experience of Lilienthal, Pilcher and Chanute
- Built a glider in Dayton in 1899
 - Moved to Kitty Hawk, N. Carolina in 1900

Reactions to the Wright's Invention

- US government was very skeptical at first
 - Not interested because of the Langley's failures
- Britain and France were very enthusiastic
- President Roosevelt directed the Secretary of War, W. H. Taft, to investigate the Wright Brothers' invention in 1906
- Dec.1907 -- Chief Signal Officer, BG James Allen, issued Specification # 486 calling for bids to build the first military aircraft

Signal Corps Specification # 486

- Established the requirements for the first military aircraft. Aircraft must be able to:
 - Carry 2 persons
 - Reach speed of 40 mph
 - Carry sufficient fuel for 125 mile nonstop flight
 - Be controllable in flight in any direction
 - Fly at least one hour
 - Land at take-off point, without damage
 - Be taken apart and reassembled in one hour
 - No Military Operational Requirements Specified

Specification # 486 (Cont)

- 41 proposals were received, only 3 complied with specifications
- US Army signed contract with Wright Brothers on 10 Feb 1908
- Wright Brothers delivered the first military aircraft on 20 Aug 1908
- US Army accepted the first operational aircraft on 2 Aug 1909

The Early Years of Flight

Closing Remarks

- Until WW I balloons, dirigibles and aircraft were primarily reconnaissance vehicles
- Early on, the flying machines were not seen as weapons of war
- Few believed the flying service was ready to be a separate air force
- The potential uses of the airplane would evolve considerably during WW I

Summary

- Early Uses of Lighter-than-Air Flying Machines
- Heavier-than-Air Flying Machines
 - The US Army's Reaction to the Wright Brothers' Invention
 - The Army's Requirements for the First Military Aircraft
- Early Uses of Airpower



History of Flight



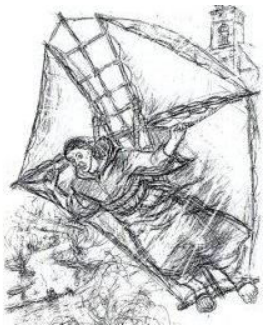

Aviation Through the Ages

1000B.C to 1250A.D

- Man's observations of the earth around him aroused his curiosity and often inspired him to attempt the impossible. How did man's lack of knowledge of the physical laws of nature sometimes bring him tragedy?
- **The Greek myth of Daedalus and his son Icarus was written around 1000 B.C. The myth states that after Daedalus built the labyrinth the king of Crete threw him in it to test it. He and his son Icarus escaped by building wings of wax and flying away. However Icarus flew too high and the wax in his wings began to melt. His wings collapsed and he plunged to his death in the sea.**
- **Kites flown around the year 400 B.C. in China were ancestors of modern aviation and the airplane. In the year 1020 A.D. Oliver of Malmesbury put on a pair of wings and leapt from the top of an abbey. He landed very hard and broke his legs. Luckily he survived the crash. Many others attempted to fly with "wings" but all failed, sometimes fatally.**



Aviation Through the Ages

1250 to 1750

- I was one of the first to experiment with the science of flying. Unfortunately my writings and sketches weren't discovered until three hundred years after my death.
- **Leonardo da Vinci spent most of his life exploring flight and left the world about 160 documents of sketches and observations about flight. He made important discoveries about the center of gravity, the center of pressure, and streamlining. But like so many people of his time he was obsessed with learning to fly like a bird. What is the difference between simply gliding and really flying like a bird?**

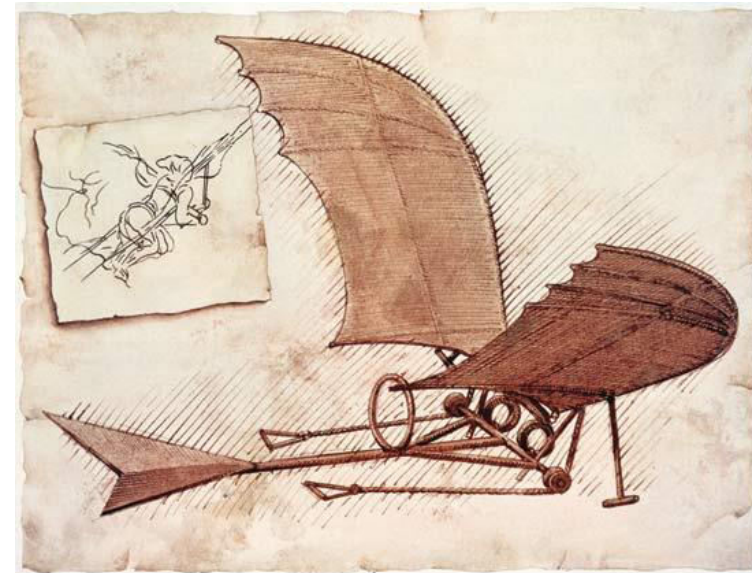
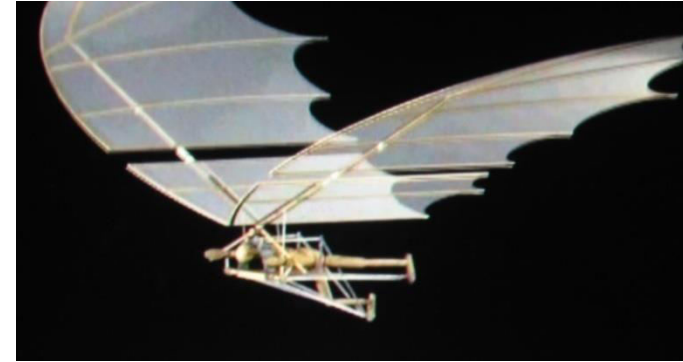

Aviation Through the Ages

1750 to 1850



- What forces cause smoke to rise in a fireplace? This was what sparked Montgolfier's curiosity.
- **Joseph and Etienne Montgolfier designed the first successful flying craft. Their observations led them to believe that burning created a gas, which they called "Montgolfier's gas," causing a craft to rise. They constructed a balloon made of cloth and paper. The first aviators were a duck, rooster, and a sheep. Then in 1783 a crowd in Paris watched as a Montgolfier balloon carried two French men. The way the balloons worked is hot air and gases filled the balloon causing it to lift. Once it was in the air it simply went wherever the wind took it. To counter this problem Henri Giffard designed a round oval shaped balloon called a [blimp](#) and combined it with a steam engine to make it steerable. When gasoline engines were invented they became a major source of transportation across the Atlantic Ocean. The Hindenburg [zeppelin](#) disaster in 1937 caused the end for these large [airships](#).**



Aviation Through the Ages

1850 to 1900

- Sir George Cayley set in motion the future study of aerodynamics in a single sentence. "The whole problem is confined within these limits, namely to make a surface support a given weight by the application of power to the resistance of air."
- **Sir George Cayley experimented with [gliders](#) at his home in Yorkshire. He was the first to discover how wings work. Cayley discovered that wings are lifted on the air. He also constructed the first aircraft that was heavier than air. He is now recognized as the father of aviation. He came up with many principles of heavier-than-air flight.**

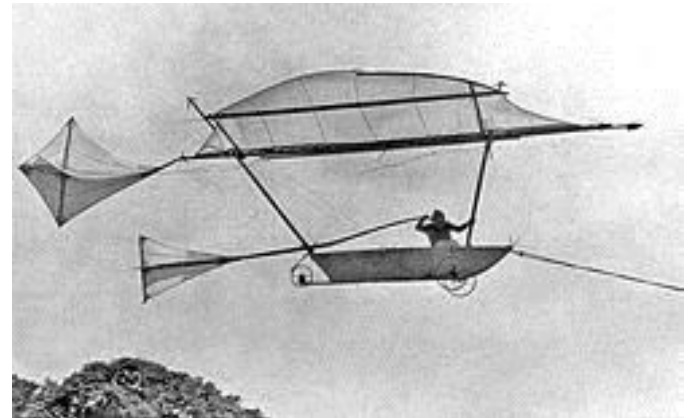

Aviation Through the Ages

1850 to 1900

- In 1896, the German engineer, Otto Lilienthal, tested several monoplane and biplane gliders. He built and flew the first glider capable of carrying a person, but died when he crashed in a sudden gust of wind before he could finish his powered plane.
- The structure of an airplane as we know it today was in its formative years. What are the parts of a plane and how does each function?



AIRPLANE

- An **airplane** is a vehicle heavier than air, powered by an engine, which travels through the air by the reaction of air passing over its wings.
- **FUSELAGE**
The **fuselage** is the central body portion of an airplane which accommodates the crew and passengers or cargo.
- **COCKPIT**
In general aviation airplanes, the **cockpit** is usually the space in the fuselage for the pilot and the passengers: in some aircrafts it is just the pilot's compartment.
- **LANDING GEAR**
The **landing gear**, located underneath the airplane, supports it while on the ground.
- **WINGS**
Wings are the parts of airplanes which provide lift and support the entire weight of the aircraft and its contents while in flight.

EXPERIMENT 2

Equipment:

- 2 sheets of notebook paper
- Hold two sheets of notebook paper about four inches apart. Blow between them. Instead of flying apart they come together. The air moving rapidly between the two pieces of paper has less pressure than the air pressing on the outer sides of the paper.

Equipment:

Ping-pong ball

- Tank-type vacuum cleaner
- Connect the hose to the blower rather than to the suction end of the vacuum cleaner. Turn the switch on. Hold the hose vertically so the stream of air goes straight up. Release the ping-pong ball into the stream of air about a foot from the nozzle. Slowly tip the nose so that air shoots at an angle. The ball will stay suspended in the airstream. The force of gravity upon the ball tends to make it drop out of the airstream. However, the fast moving airstream lessens the air pressure on the portion of the ball remaining in the airstream, overcoming the force of gravity, which results in the ball remaining suspended.

Aviation Through the Ages

1900 to 1935

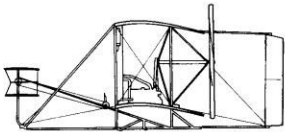
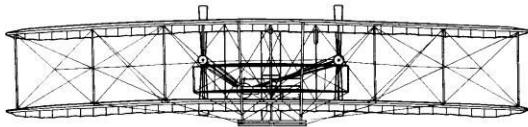
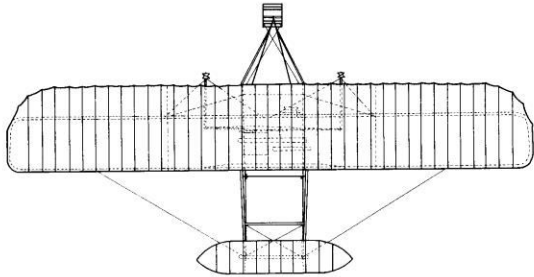

- "Only those who are acquainted with practical aeronautics can appreciate the difficulties of attempting the first trials of a flying machine in a 25-mile gale. . . but. . . we were determined. . . to know whether the machine possessed sufficient power to fly."
- That was Wilbur Wright's statement to *The Associated Press*, January 5, 1904.
- **At 10:35 a.m. on December 17, 1903 the world's first successful airplane known as the *Flyer I* accelerated along its launching rail and flew through the air. Twelve seconds later it landed 100 yards away on the soft sand at Kill Devil Hills near Kitty Hawk, North Carolina. The pilot Orville and his brother Wilbur had experimented for four years with kites and engines to make the first successful flight ever.**
- The brothers had made their own engine that weighed 200 pounds and had four [cylinders](#). It could make 12 horse power, a sixth of the engine power of a small car. It had no seat and the pilot had to lay in a cradle in the bottom wing.



Aviation Through the Ages

1900 A.D to 1935 A.D

- The Wright brothers continued to perfect their plane and it was in a Wright [biplane](#) that the first transcontinental flight was made by Calbraith P. Rodgers, in 1911.

The key to their success was to learn how to control the plane. How were they able to accomplish this task?

- In 1914 World War I broke out. At first planes were used mostly for reconnaissance, but later planes developed into [biplane](#) and triplane fighters and bombers. Experiments were done with even more sets of wings, but most failed. The main fighters of the war were the British Sopwith "Camel," its cousin, "[The Snipe,](#)" and the famous [German Fokker Df.I](#) which was flown by the infamous [Red Baron](#). Aerial tactics and strategies were developed during the middle of the war. Germany developed many [fighter](#) tactics that are still in modified use today. The compass was an important instrument to these early fighters. How do they work? How has the technology changed over the decades?

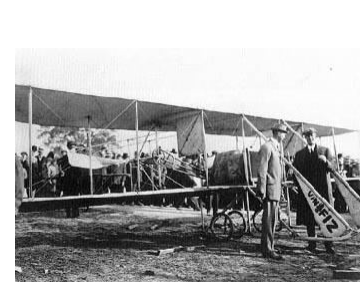

Aviation Through the Ages

1900 to 1935

- After the war General Billy Mitchell became an advocate for military aviation. He and his pilots achieved many firsts in the field of aviation during these golden years. But the Europeans were leading the race in commercial flight. It wasn't until Ralph Pulitzer offered a trophy to promote high-speed flight and began a national craze for air races that the American public began to take notice.
- In 1918, the Post Office Department started airmail service in the United States. The first [Mailwing](#) was built by Pitcairn Aviation, Inc. In 1926, Congress passed the Air Commerce Act. This established an Aeronautics Branch within the Department of Commerce. They were authorized to license planes and pilots and provide standards for commercial flight. And in 1927, [Charles Lindbergh](#) completed the first [transatlantic](#) flight. He instantly became a world hero.
- [Amelia Earhart](#) was the first woman to fly solo across the Atlantic in 1928.



Aviation Through the Ages

1935 A.D to 1950 A.D

- New technologies developed throughout the course of World War II. The motto was if you commanded the skies you could win the war.
- **World War II implemented almost exclusively monoplanes. Both sides of the war manufactured literally thousands of fighters and bombers. The main Allied planes included the British Supermarine Spitfire Mk.IV, the American P-51 Mustang, the American C-4U Corsair, the American B-17, and the American B-29 Superfortress. The Grumman F6F Hellcat was first used in 1943 and became the premier carrier fighter plane. The main Axis planes were the Bf109, the Junkers Ju-22, and the Stuka dive-bomber. The mainstay of the Japanese forces was the feared Mitsubishi Zero-sen. Our hangar also includes the North American T28 B and the AT-6 Texan, other planes from this period.**



Aviation Through the Ages

1935 A.D to 1950 A.D

- The major air battle of WW II was the Battle of Britain. For days the much larger German Luftwaffe attacked the British Isles, but the small number of British Spitfires always seemed to know exactly where and when the German bombers would be attacking and how large of a force. The reason for this was a relatively new technology called [radar](#) allowed the British ground stations to detect and identify the size, speed, distance, and trajectory of the German [bombers](#) and send their Spitfires on perfect intercept missions.



Aviation Through the Ages

1935 A.D to 1950 A.D



- Instrumentation was crude in comparison to today's technology. In the early days pilots relied on landmarks and sometimes even pre-set bonfires to guide them along their way. What were the early instruments like and what were their functions? How has instrumentation evolved through the ages?
- In the late 1940's, the military had developed the [jet engine](#) and began changing over to jet fighters. This resulted in faster and better performing craft. New aviation records were set. In 1947, [Chuck Yeager](#) broke the sound barrier.



Aviation Through the Ages

1950 A.D to 1975 A.D

- After Chuck Yeager's supersonic flight in 1947, aviation entered a new era dominated by jets.
- **The years following the war saw the aviation industry grow in leaps and bounds. The military airforce developed more effective planes to address the arms race with Russia. The B-47 and [B-52 bombers](#) were built to be used to deliver nuclear bombs. They were the world's heaviest bombers and could hold up to 99,206 pounds of bombs. Early bombers flew so high that the crew had to wear [pressure suits](#) but later they were used at low altitude because they were harder to locate with [radar](#).**



Aviation Through the Ages

1950 A.D to 1975 A.D

- In September, 1955, a contract was awarded to North American Aviation for the [X-15](#) plane which could fly at 4,500 miles per hour at an altitude of at least 70,000 feet. 54 percent of its total weight was its fuel (18,000 pounds). The total weight of the X-15 was 33,000 pounds. Though only three of this type of plane were built they flew a total of over 200 times. The highest speed ever reached was about 4,525 miles per hour or Mach 6.72.



Aviation Through the Ages

1950 A.D to 1975 A.D

- In 1958, the first American commercial jet, the 707, was put into service by the Boeing Company. The commercial liners were an instant hit with passengers who appreciated the faster flying time. Again new records were set. By 1966 both Lockheed and Douglas Aircraft Corporations had entered the commercial industry giving rise to competition and the development of new technologies.
- During the Vietnam War the use of military air power was somewhat limited by policy in Washington. President Nixon launched the only strategic bombing campaign of the war. Many fliers were shot down over Southeast Asia. They were recently honored in a ceremony dedicating the [Missing Man Monument](#) at Randolph Air Force Base, in Texas.

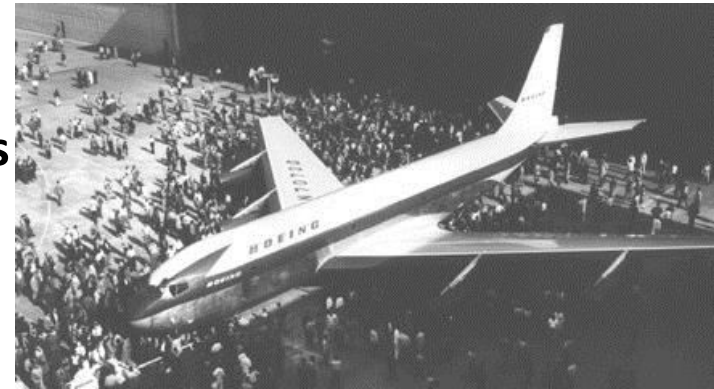

Aviation Through the Ages

1975A.D to 2000A.D



- Aviation has changed much since the beginning of time.
- The world's first **supersonic** commercial passenger aircraft operating regular scheduled flights was the Concorde. It was developed jointly by Great Britain and France during the 1960s and 1970s when the Comet 4, the DC-3, and the Constellation were in regular service. No other supersonic aircraft can fly as fast and as far as the Concorde without needing mid-flight refueling. Some military aircraft can fly faster, but need in-flight refueling. The Concorde flies literally on the edge of space, high through the atmosphere. Passengers are even capable of seeing the earth's surface.
- **The Nighthawk (F-117A)** first flew in 1981 and began combat in 1989. This jet was designed to avoid detection and mount precision attacks. It is the first **stealth** combat aircraft in the world. It has a top speed of 593 mph (955 kph) and is loaded with 5,000 lbs. of weapons. The choice of weaponry varies from laser-guided bombs, air-to-air missiles, or air-to-surface missiles. Two types of weapons can be carried at one time. The outside of the Nighthawk is coated with a special material that absorbs some of the radar signals that strike it. It is protected by 24 hour security with armed guards all around it. Authorized personnel must pass a palm print test to get near the aircraft.



Aviation Through the Ages

1975A.D to 2000A.D

- **The CL-415, or "Firebird," is a very important aircraft. This aircraft is amphibious, which means it can be operated from land or water. It was developed by Canadair to stop raging forest fires. However, it is also useful for search and rescue missions, especially on the sea. It can search for survivors for up to seven hours before refueling. It can scoop water into its tanks. Through doors in the bottom of the aircraft it drops water on the fire.**
- **The age of computers continues to impact the aviation field. Today's technology is exciting and it seems as if "the sky's the limit" as we look into the future.**



Aviation today and tomorrow

- Boeing 787 designed completely on the computer
- will carry 250 - 290 passengers on routes of 8,000 to 8,500 nautical miles
- The airplane will use 20 percent less fuel for comparable missions than today's similarly sized airplane. It will also travel at speeds similar to today's fastest wide bodies, Mach 0.85. Airlines will enjoy more cargo revenue capacity.



Martin Aircraft - Maryland

- 1937 Mini-Mariner, the flying prototype of the WWII flying boat bomber



A PBM-3 Martin Mariner in flight

*Martin PBM-5A Mariner.
This was the only amphibious version
of the Mariner.*



Basic Properties of the Atmosphere

Essential Points

1. Heat, Temperature and Temperature Scales
2. The Electromagnetic Spectrum
3. Composition of the Atmosphere
4. Layers in the atmosphere are defined by temperature profiles
5. How pressure varies in the atmosphere
6. Principal weather instruments
7. Earth's radiation budget

Heat and Temperature

- Temperature: *Average* energy of molecules or atoms in a material
- Heat: *Total* energy of molecules or atoms in a material
- Can have large amount of heat but low temperatures
- Can have high temperatures but little heat

Heat and Temperature

- The earth's outermost atmosphere is extremely "hot" but its heat content is negligible
- The surface of the moon can reach 250 F in sunlight and -200 F in shadow, but the vacuum around the Apollo astronauts contained no heat.
- It takes time for things to warm up and cool off.

Temperature Scales

- Fahrenheit
 - Water Freezes at 32 F
 - Water Boils at 212 F
- Centigrade or Celsius
 - Water Freezes at 0 C
 - Water Boils at 100 C
- Two scales exactly equal at -40

Absolute Temperature

- Once atoms stop moving, that's as cold as it can get
- Absolute Zero = $-273\text{ C} = -459\text{ F}$
- Kelvin scale uses Celsius degrees and starts at absolute zero
- Most formulas involving temperature use the Kelvin Scale

Electromagnetic Radiation

- Radio: cm to km wavelength
- Microwaves: 0.1 mm to cm
- Infrared: 0.001 to 0.1 mm
- Visible light 0.0004 – 0.0007 mm
- Ultraviolet $10^{-9} - 4 \times 10^{-7}$ m
- X-rays $10^{-13} - 10^{-9}$ m
- Gamma Rays $10^{-15} - 10^{-11}$ m

Composition of the Atmosphere

- Nitrogen 78.08%
- Oxygen 20.95%
- Argon 0.93% (9300 ppm)
- Carbon Dioxide 0.035% (350 ppm)
- Neon 18 ppm
- Helium 5.2 ppm
- Methane 1.4 ppm
- Ozone 0.07 ppm

Other Components of the Atmosphere

- Water Droplets
- Ice Crystals
- Sulfuric Acid Aerosols
- Volcanic Ash
- Windblown Dust
- Sea Salt
- Human Pollutants

Structure of the Atmosphere

- Defined by Temperature Profiles
- Troposphere
 - Where Weather Happens
- Stratosphere
 - Ozone Layer
- Mesosphere
- Thermosphere
 - Ionosphere

Troposphere

- Heating of the Surface creates warm air at surface
- Warm air rises, but air expands as it rises and cools as it expands (Adiabatic cooling)
- Heating + Adiabatic Cooling = Warm air at surface, cooler air above
- Buoyancy = Cool air at surface, warmer air above
- Two opposing tendencies = constant turnover

Stratosphere

- Altitude 11-50 km
- Temperature increases with altitude
- -60 C at base to 0 C at top
- Reason: absorption of solar energy to make ozone at upper levels (ozone layer)
- Ozone (O_3) is effective at absorbing solar ultraviolet radiation

Mesosphere

- 50 – 80 km altitude
- Temperature decreases with altitude
- 0 C at base, -95 C at top
- Top is coldest region of atmosphere

Thermosphere

- 80 km and above
- Temperature increases with altitude as atoms accelerated by solar radiation
- -95 C at base to 100 C at 120 km
- Heat content negligible
- Traces of atmosphere to 1000 km
- Formerly called Ionosphere

Why is the Mesosphere so Cold?

- Stratosphere warmed because of ozone layer
- Thermosphere warmed by atoms being accelerated by sunlight
- Mesosphere is sandwiched between two warmer layers

How Heat Moves

- Radiation
- Conduction
- Convection

Magnetosphere

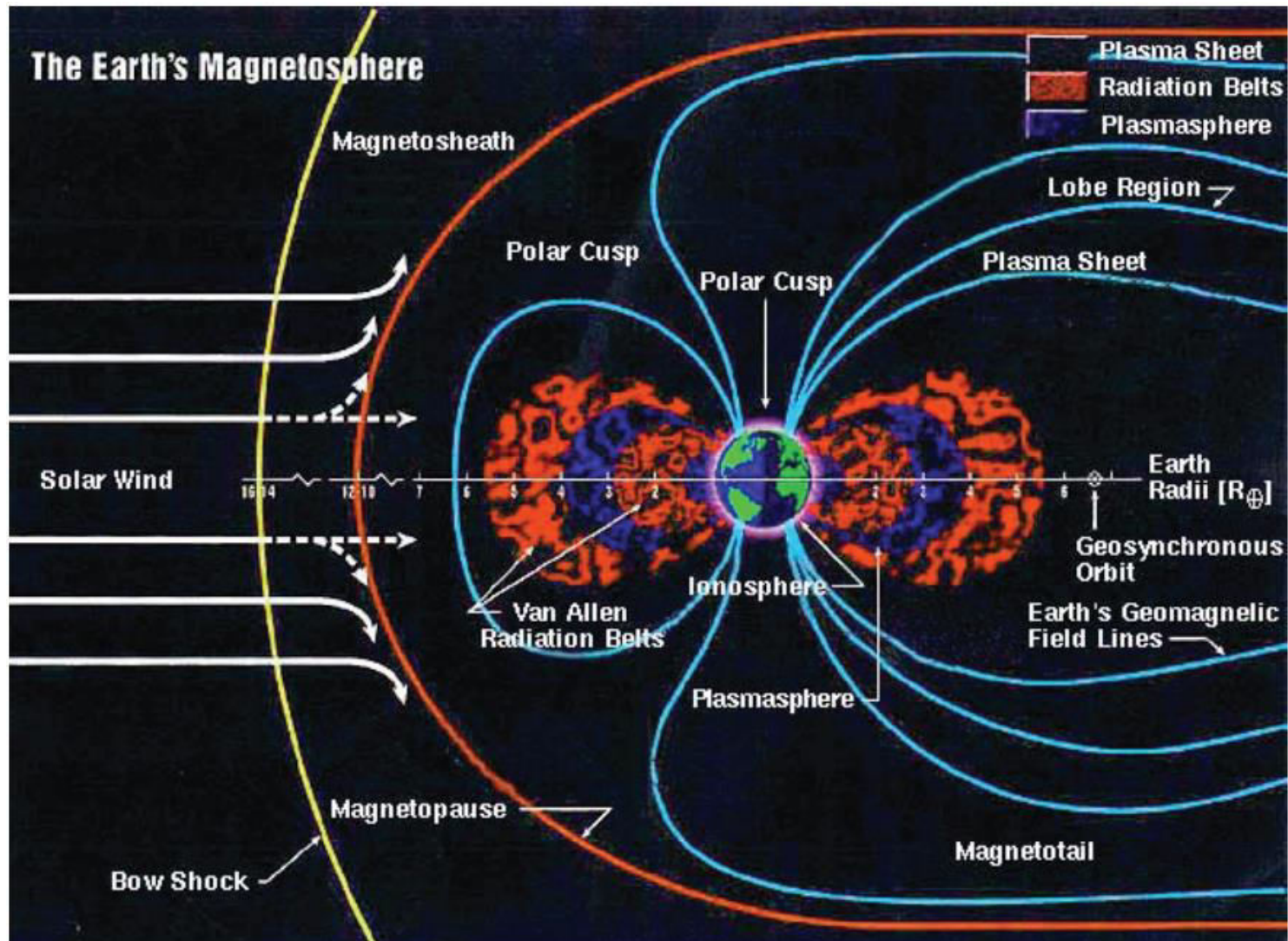

Effects of Spacecraft / Plasma Interactions

- plasma wave generation
- arcing and sputtering at significantly high negative potential relative to the plasma
- spacecraft charging at high inclination orbits
- current balance between the space vehicle and the ambient plasma
- geomagnetic field effects

Solar Environment

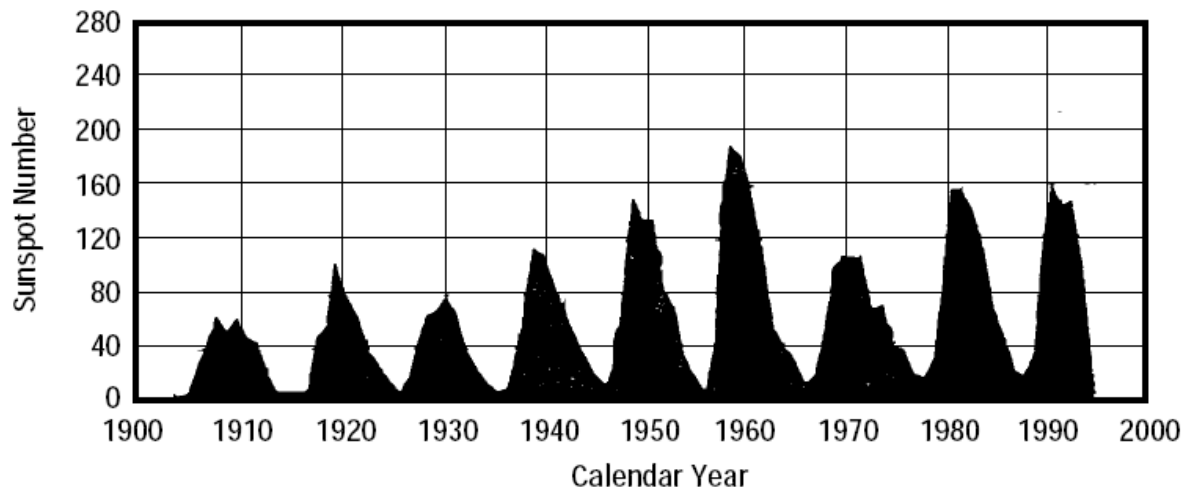
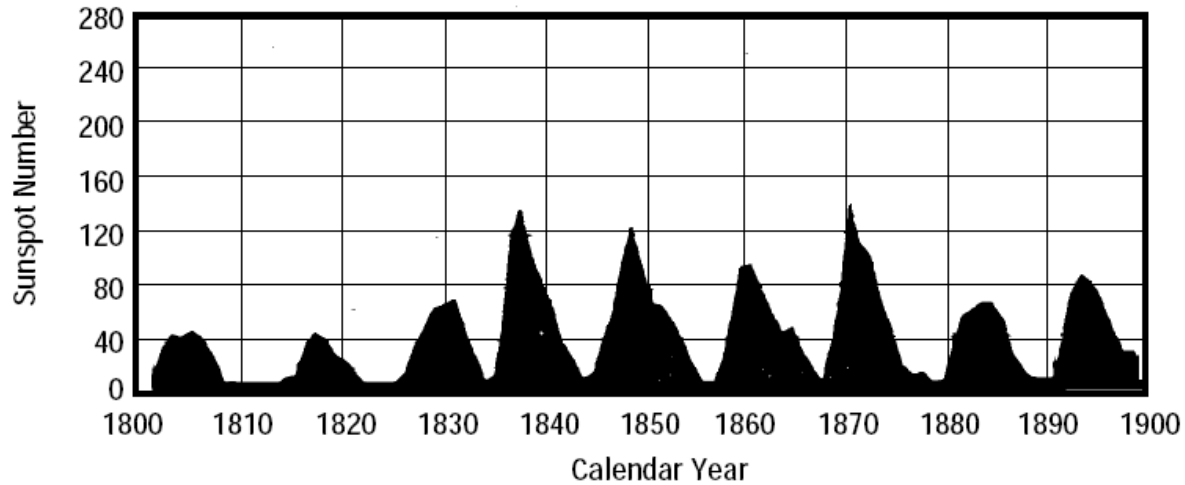

Solar Wind

- The solar wind is a stream of energized, charged particles, primarily electrons and protons, flowing outward from the Sun
- Composition similar to the Sun's corona
 - Protons (~ 70%), electrons, ionized helium, less than 0.5% minor ions
 - Genesis mission
- Approximately 10^9 kg/s of material is lost by the sun as ejected solar wind
- Speed: 200 – 900 km/s
- Solar sail
- Solar wind is also a plasma environment
 - Not just gas
 - Electrically conductive

Ionizing Radiation

- Radiation has a major impact on on-board digital circuitry
 - Long-term degradation and failure (ranges from months to years)
 - Short-term, single event effects (SEE)
 - Minor (bit flips)
 - Major (catastrophic burnout)

Radiation Effects

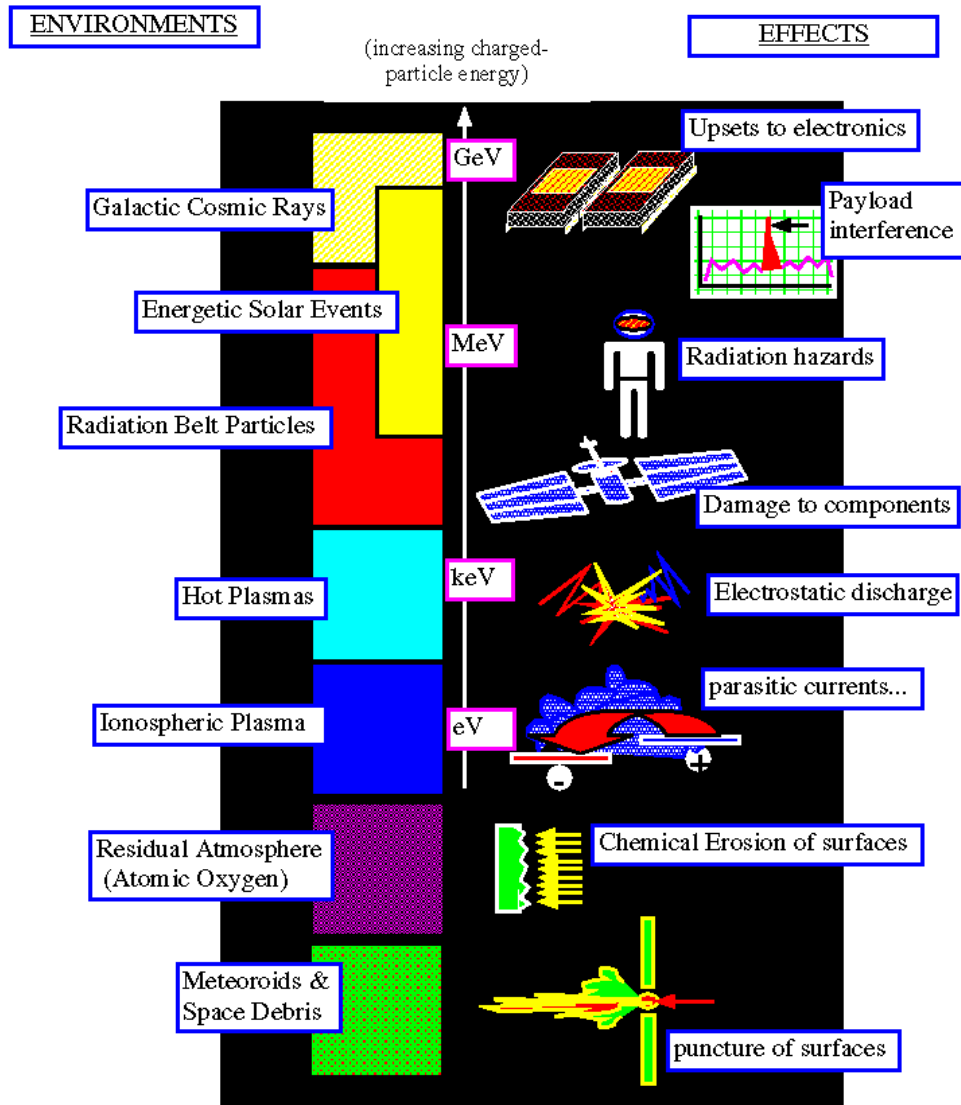

Radiation Belts

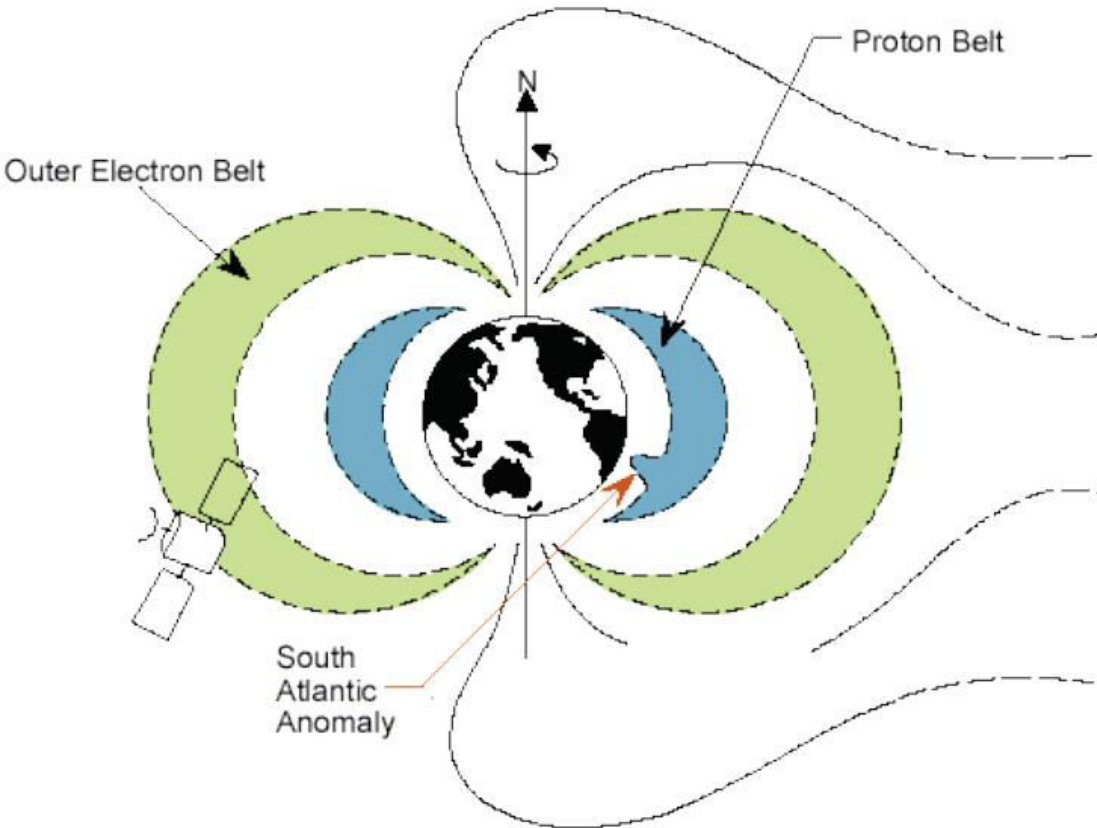

- Two belts (donut shaped)
- Magnetic field traps the particles
- Discovered by Explorer III in 1958
- Composed of
 - Electrons
 - Protons
 - Some heavy ions
- Effects
 - Electrons: total dose
 - Protons: total dose and SEE
 - Ions: SEE

Movement of Particles

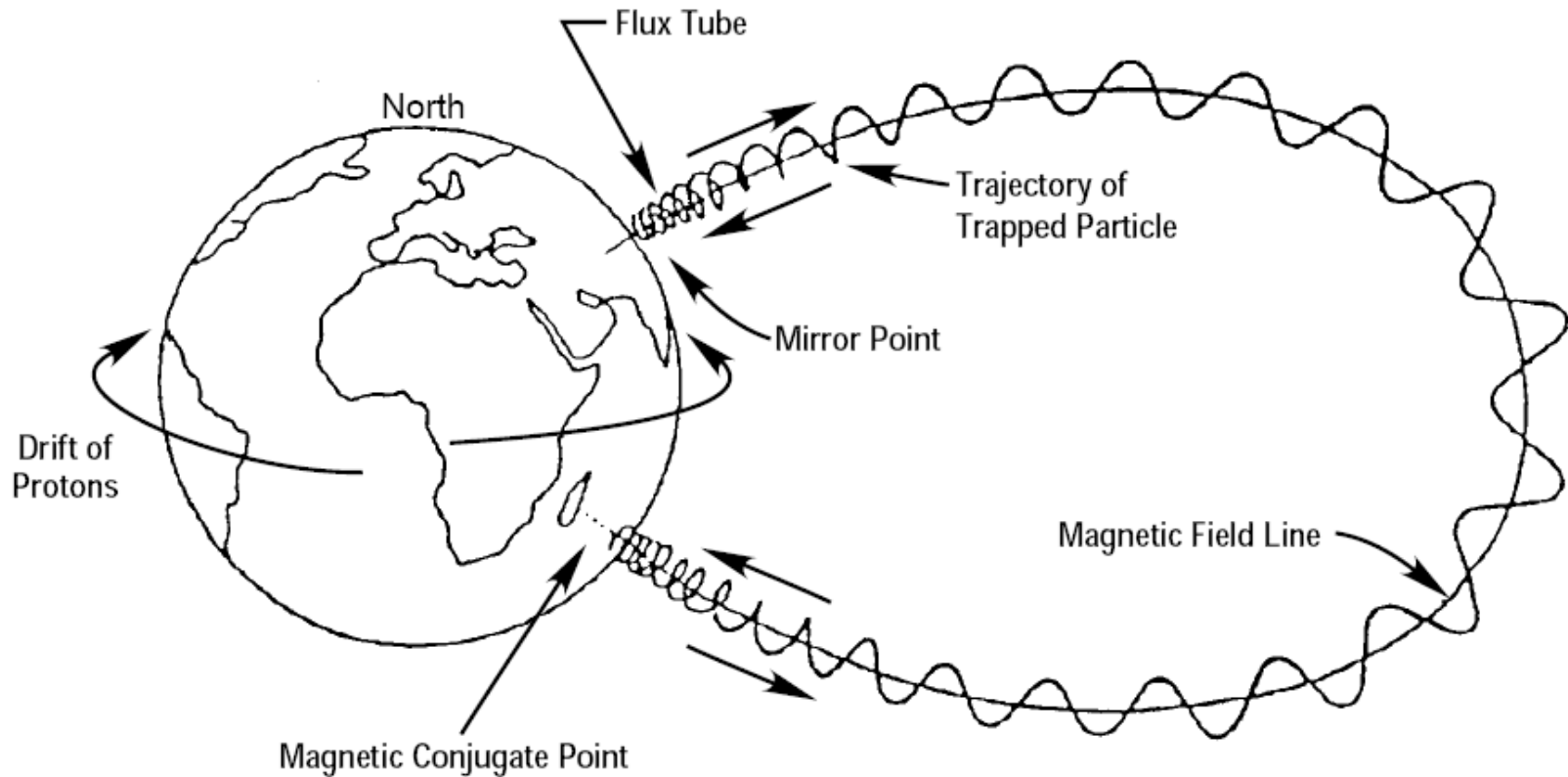

South Atlantic Anomaly

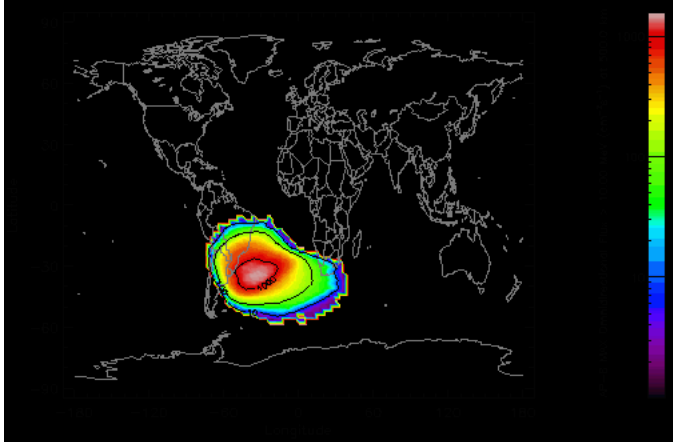

- Magnetic field weaker in South Atlantic
- Result is particle penetration
- Note polar effect as well
- SEU effect on UoSat-2

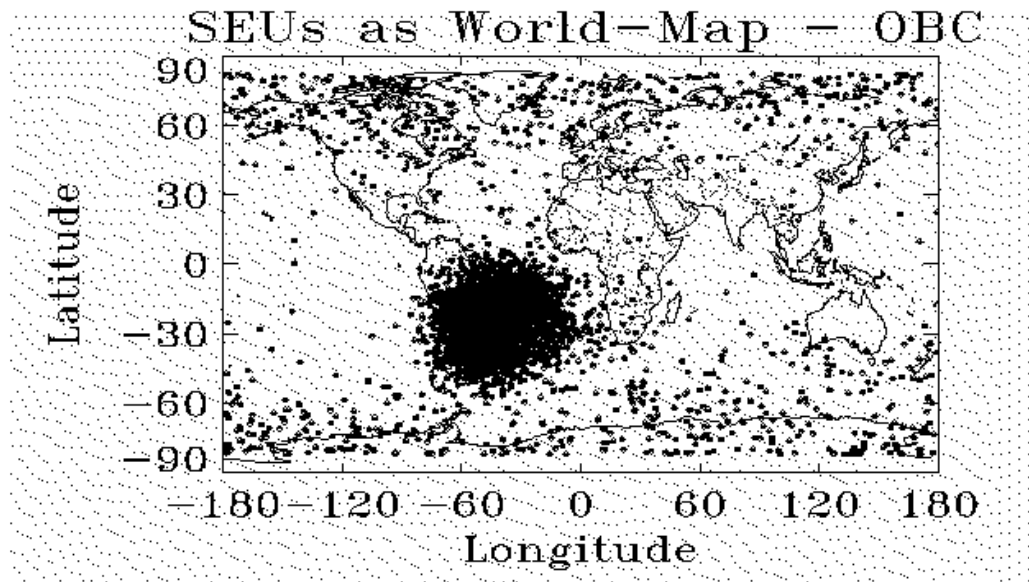
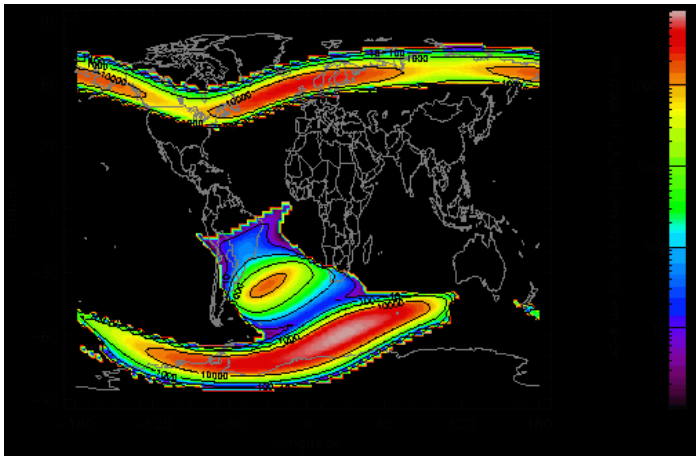

Galactic Cosmic Rays

- High energy particles from interstellar space
- Flux inversely related to solar max periods
- Primary effect
 - Single event upsets

Radiation Effects on Spacecraft: Solar Cells

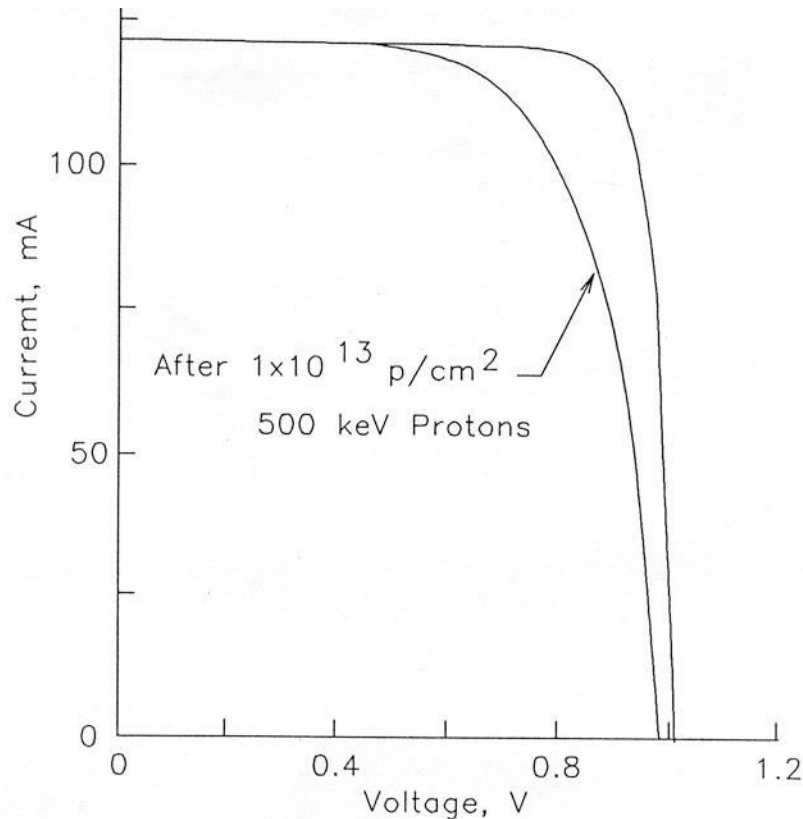

GaAs/Ge Solar Cell Performance after Irradiation with 500 keV Protons to a Fluence of 1×10^{13} p/cm²

- High energy protons & electrons collide with the crystal lattice structure
- Collisions displace atoms from their lattice sites
- Eventually, the displaced atoms form stable defects
- Defects change the propagation of photoelectrons in the lattice structure

Radiation Effects on Spacecraft: Solid State Devices

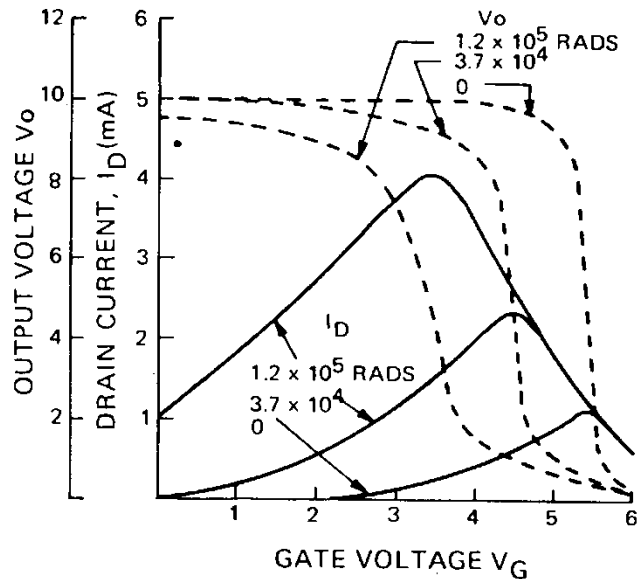

Change in CMOS Inverter Transfer Characteristic for Condition I (V_I , the Gate Bias During Irradiation, is 0 Volts for the p-Channel and +10 Volts for the n-Channel; V_{DD} is 10 Volts.)

- Nominal MOS or CMOS technology
- Charged Particles:
 - Voltage output of a “GATE” switches abruptly from a “0” to a “1” at a specified voltage
- Radiation:
 - Switching threshold changes
 - Drain current and output voltage also change
- Effects caused by cumulative effect of high energy protons and electrons (Cumulative Dosage measured in rads)

Summary of Radiation Types

Radiation Source	Particle Type	Primary Effects
Trapped radiation belts	Electrons Protons	Ionization damage; Ionization, SEE.
Galactic Cosmic Rays	High-energy, heavy, charged particles	SEE
Solar Flares	Electrons Protons Lower-energy, charged particles	Ionization Ionization, SEE SEE

Meteoroid/Orbital Debris

- Meteoroid population consists the remnants of comets, spent rocket stages, fragments of rockets and satellites, other hardware, as well as operational satellites.

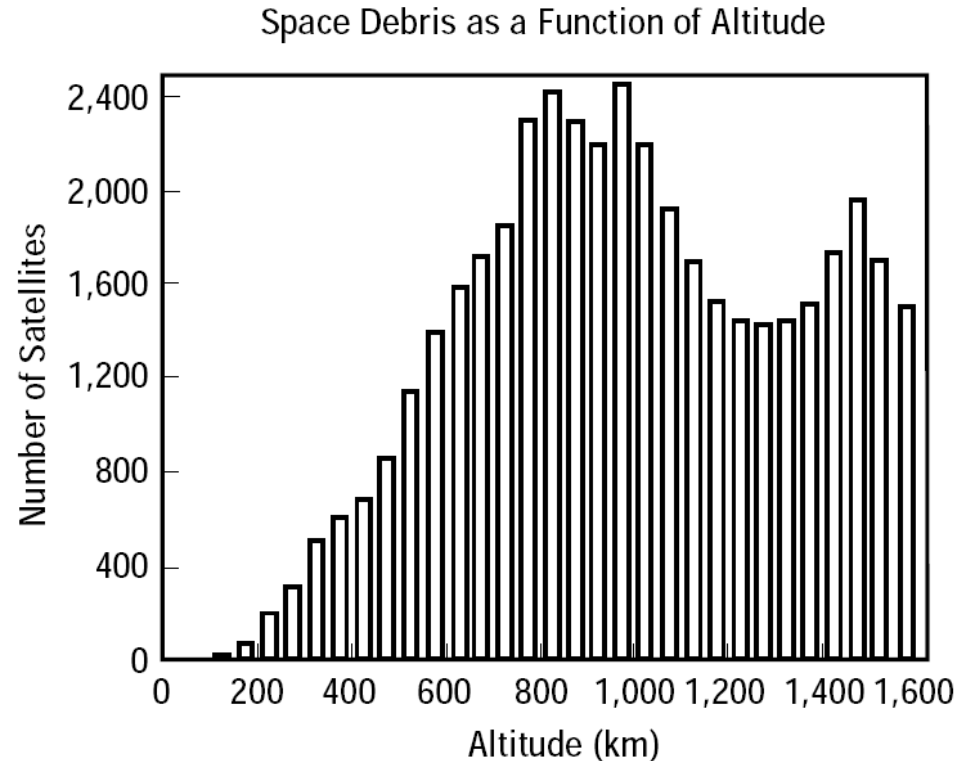
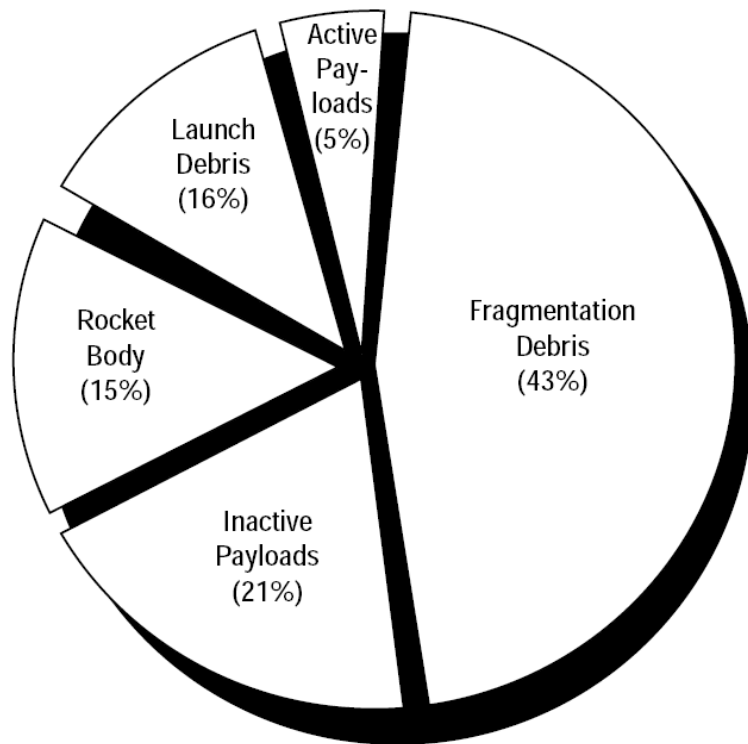

Micrometeoroids/Orbital Debris

- Example collisions
 - Russia/US satellites collision
 - Cerres/Ariane 3rd Stage Debris
- VERY HIGH kinetic energies
- NASA predicted results
 - Fatal spacesuit damage from 0.3 to 0.5 mm particle
 - Catastrophic shuttle damage from 4 mm particle

Micrometeoroids/Orbital Debris: Defense

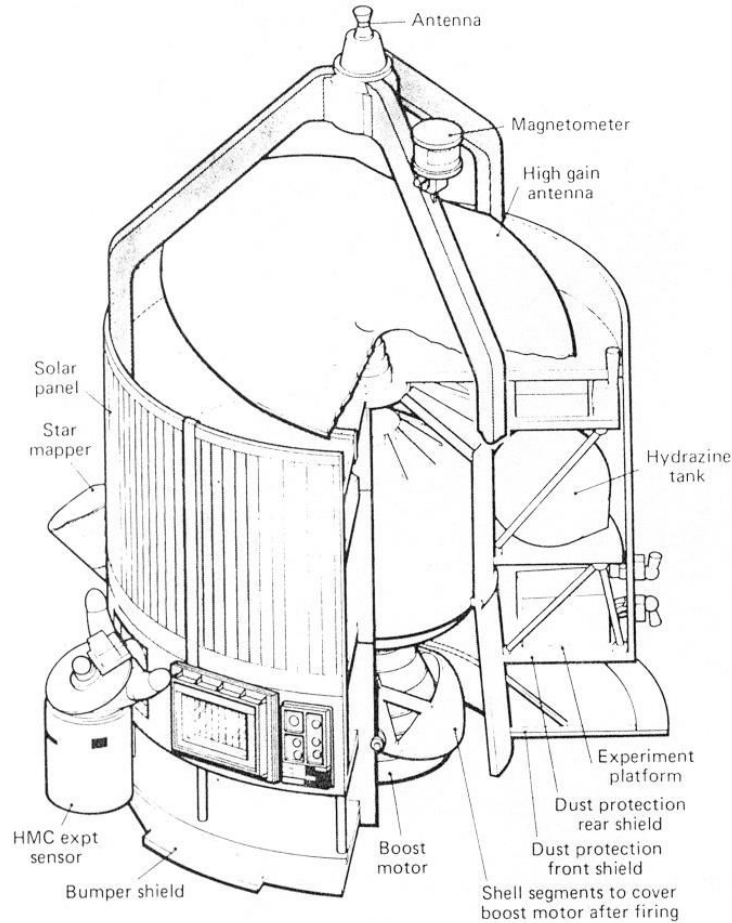

Fig. 3.29 Giotto spacecraft with Whipple meteor bumper.

- Double Wall Bumper
 - 1st wall fragments impacting particle into smaller, slower pieces
 - 2nd wall stops those pieces

ESA Scientific Spacecraft
(flew through Halley's Comet dust cloud)

Environments and Effects

Debris: Magnitude of Problem

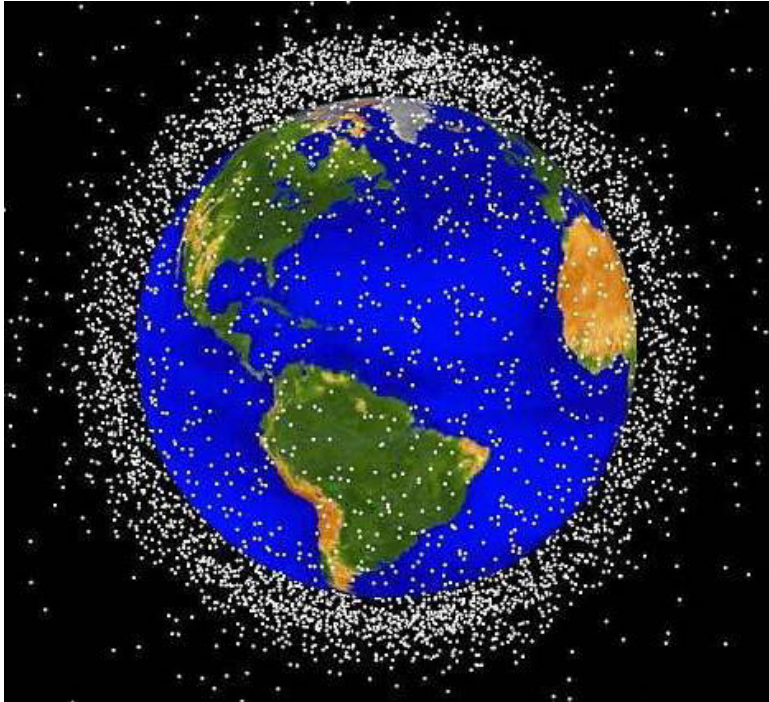

- NORAD tracks ~7000 objects larger than 10 cm
- Only 5% are operational S/C
- Statistical analysis suggests ~40,000 larger than 1 cm
- Collisions generate more debris
 - ie 1985 hypervelocity ASAT test estimated to have created 10^6 fragments between 1 mm and 1 cm diameter

Gravitational Field

- Free Fall Environment (**not** Zero-G or Microgravity)
 - At Sea Level: $a_g = 9.8 \text{ m/s}^2 = 1.0 \text{ g}$
 - At 200 km: $a_g = 9.2 \text{ m/s}^2 = 0.94 \text{ g}$
 - At 1000 km: $a_g = 7.3 \text{ m/s}^2 = 0.75 \text{ g}$
 - At GEO: $a_g = 0.2 \text{ m/s}^2 = 0.023 \text{ g}$
- Effects:
 - Structures/Mechanisms: *Minimum size structural components*
 - Propulsion: *Fuel flow (ullage burns, etc)*
 - TCS: *Fluid flow considerations (heat pipes wicking)*
 - etc

Spacecraft Environment Related Anomalies

- Flare/Geomagnetic Storm
 - GOES-7: lost imagery and communications, solar arrays degraded 2-3 years worth
 - DSP: star sensor contamination, memory upsets, lost data, power panel degradation
 - Memory Upsets: DMSP, GPS, INTELSAT, TDRSS
- Spacecraft Charging
 - Milstar: power supply failure
 - Anik: momentum wheel failure
 - GOES: phantom commands
- Galactic Cosmic Ray
 - Pioneer: memory anomalies

Conclusions

- Definition of the flight environment is the first critical step.
- Not all space environments will have a critical impact on a particular mission.
- After definition of the space environment is established including results from trade studies, the next important step is to establish a coordinated set of natural space environment requirements for use in design and development.
- The space environment definition and requirements are documented in a separate program document or are incorporated into design and performance specifications.
- The environments specialist then helps insure that the environment specifications are understood and correctly interpreted throughout the design, development, and operational phases of the program.

UNIT-2

A Basic Introduction to Aerodynamics and
Propulsion

Definition

- **Aerodynamics** is the study of the motion of air, particularly when it interacts with a moving object.
- In physics the term **dynamics** customarily refers to the time evolution of physical processes.

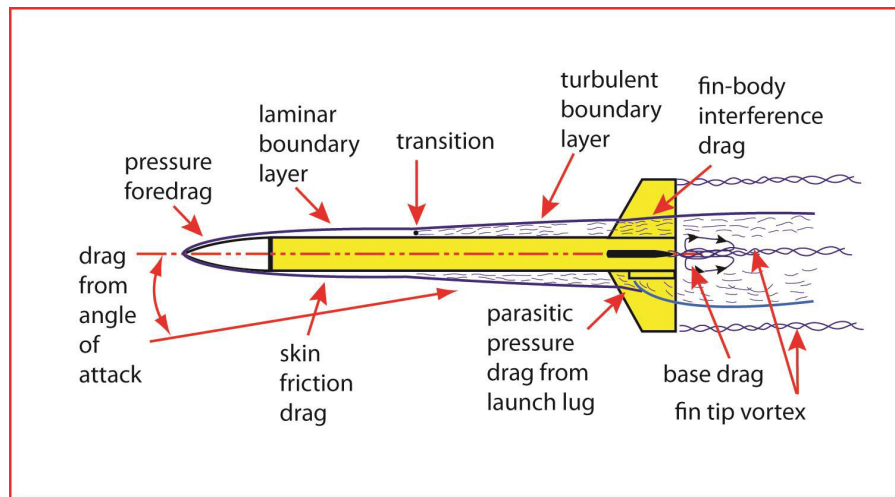

Factors that Affect Aerodynamics

The Object:

The Motion:

The Air:

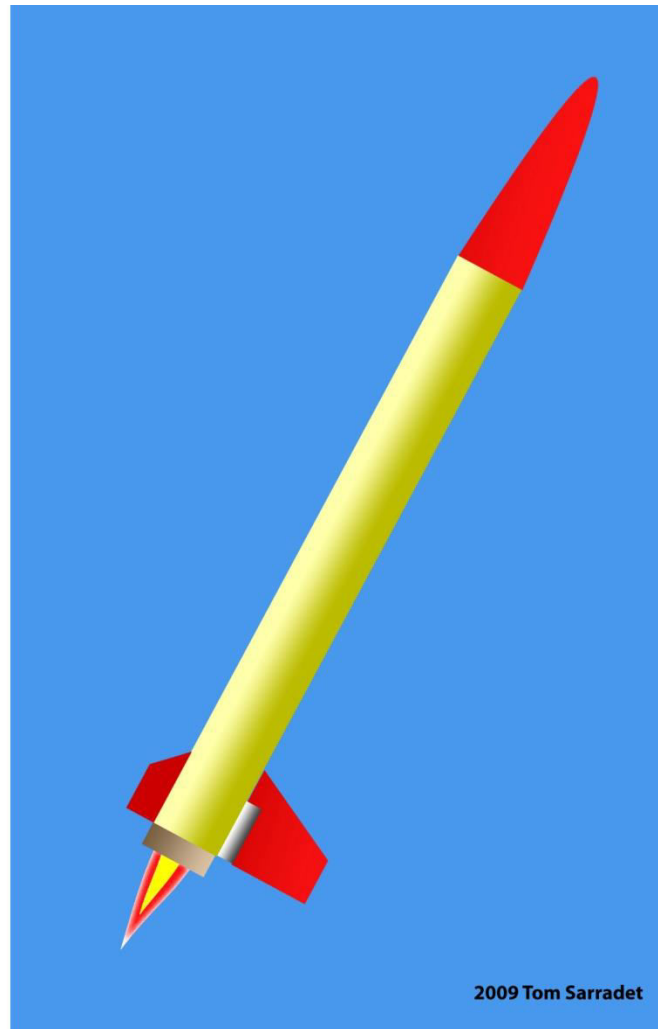

Four Forces of Flight

- **Lift** is a force used to **stabilize** and **control** the direction of flight.
- **Drag** is the **aerodynamic force** parallel to the relative wind.
- **Weight** is the force generated by **gravity** on the rocket.
- **Thrust** is the **force** which moves the rocket **forward**.

Aerodynamic Forces

- **Aerodynamic forces** are generated and act on a rocket as it **flies through** the air.
- The lift and drag act through the **center of pressure** which is the average location of the aerodynamic forces on an object.

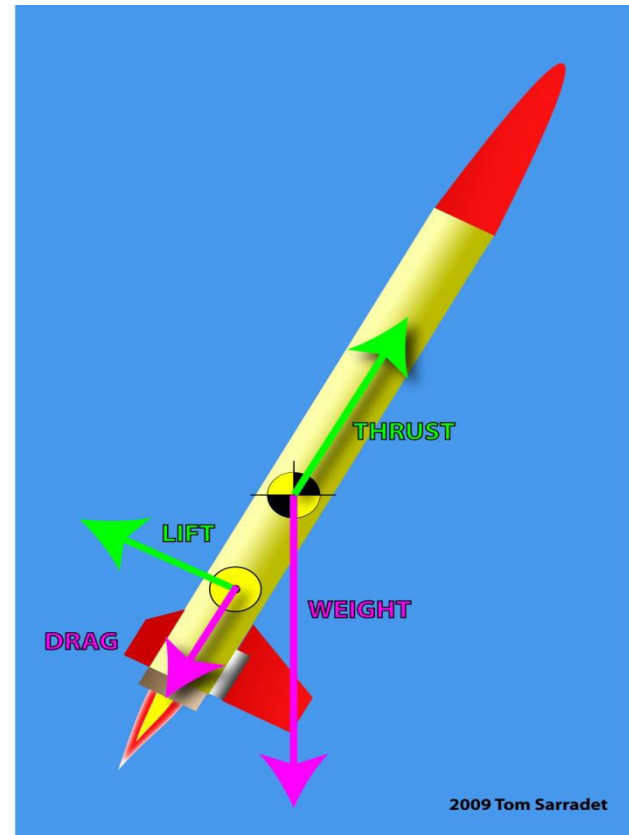

Aerodynamic Forces

- Aerodynamic forces are **mechanical forces**. They are generated by the interaction and contact of the rocket with the air.
- For **lift** and **drag** to be generated, the rocket must be moving through the air.

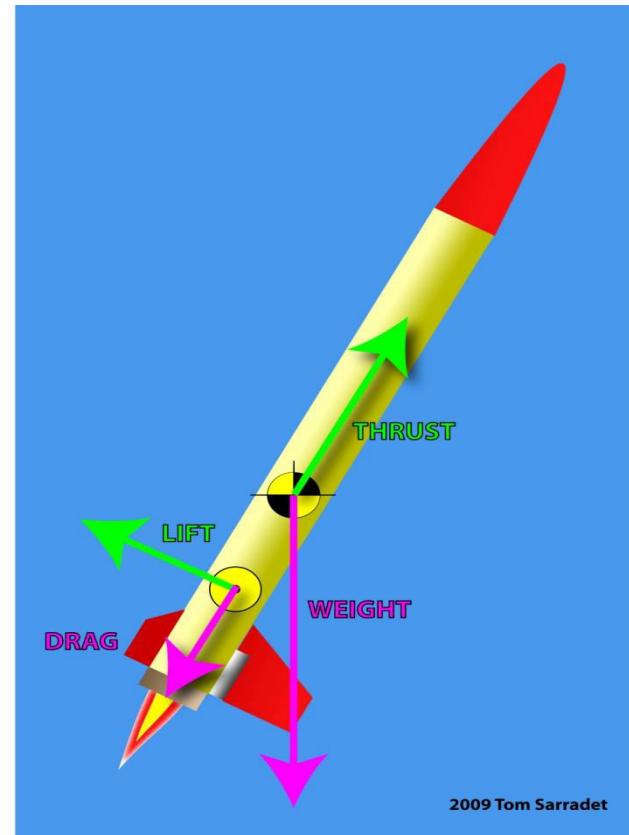

Aerodynamic Forces

- **Lift** occurs when a flow of **gas** (the air) is turned by a **solid object** (the rocket).
- The flow is turned in one direction, and the lift is generated in the opposite direction.
- For a model rocket, the **nose**, **airframe**, and **fins** can become a source of **lift** if the rocket's flight path is at an **angle**.

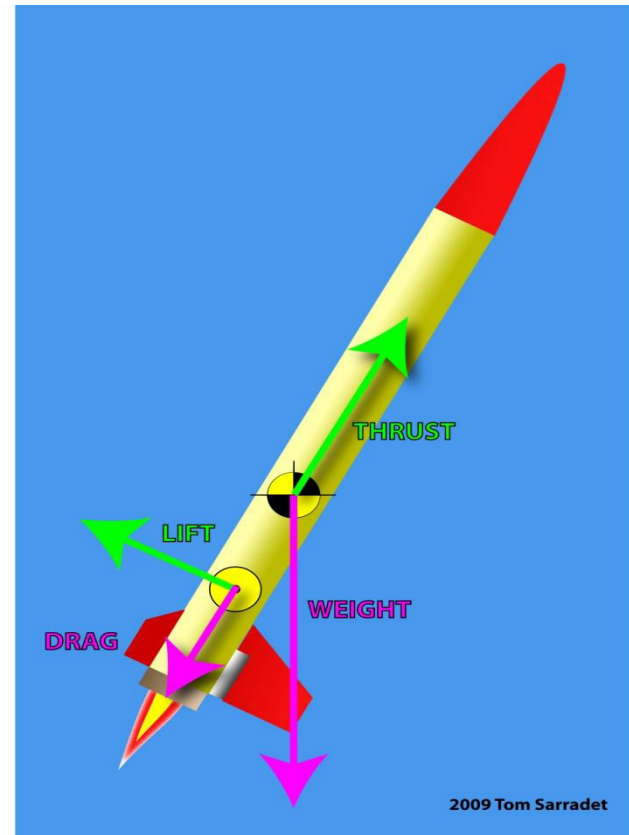

Aerodynamic Forces

- When a solid body (**the rocket**) moves through a fluid (**gas or liquid**), the fluid **resists** the motion. The rocket is subjected to an **aerodynamic force** in a direction opposed to the motion which we call **drag**.

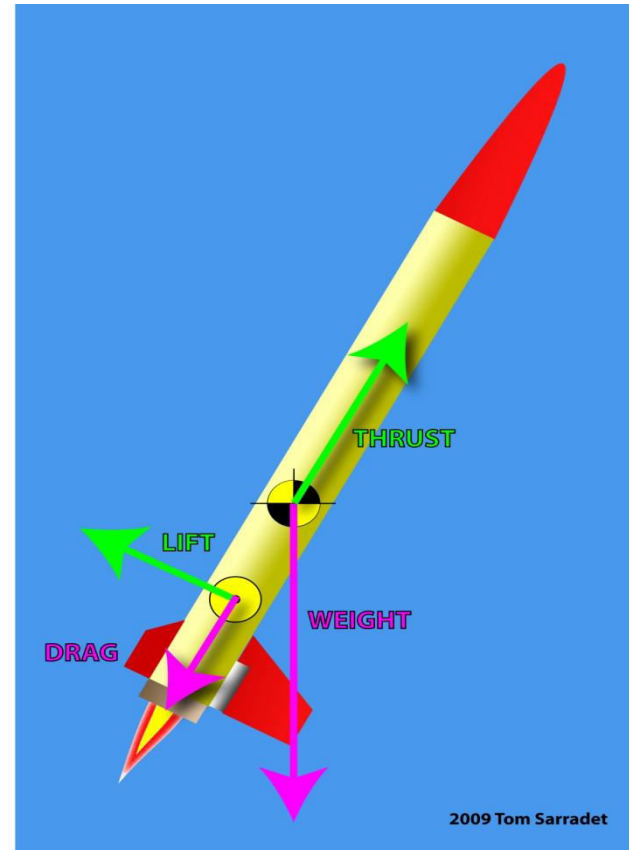

Aerodynamic Forces

- **Drag** is **aerodynamic friction**, and one of the sources of drag is the **skin friction** between the molecules of the air and the solid surface of the moving rocket.

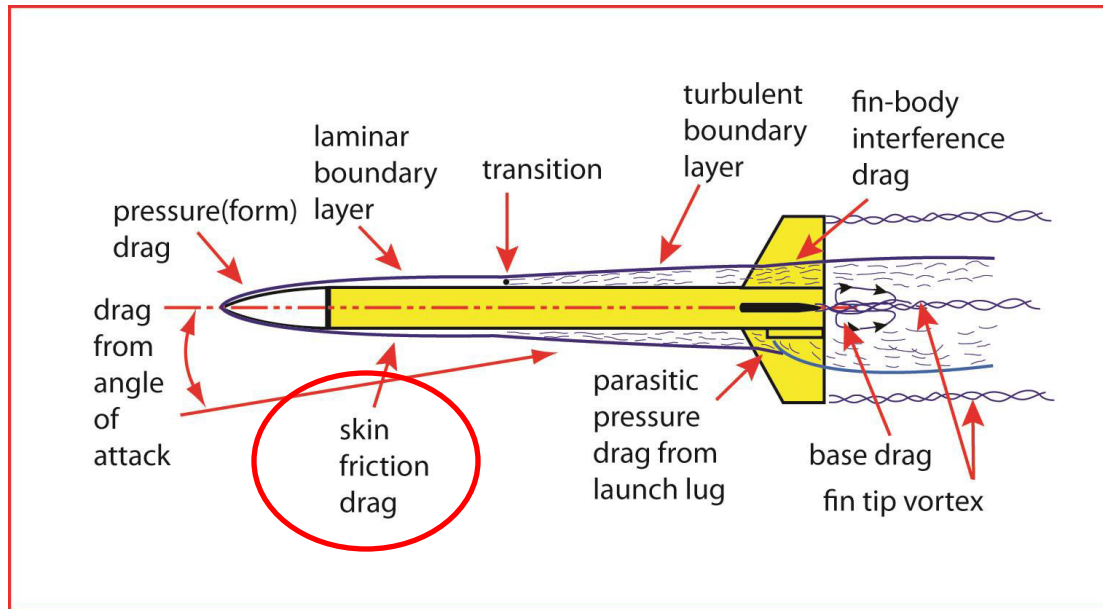

Aerodynamic Forces

- A **boundary layer** is the layer of air in the immediate vicinity of the rocket's surface.

Boundary layers can be **laminar** (smooth flow) or **turbulent** (swirling).

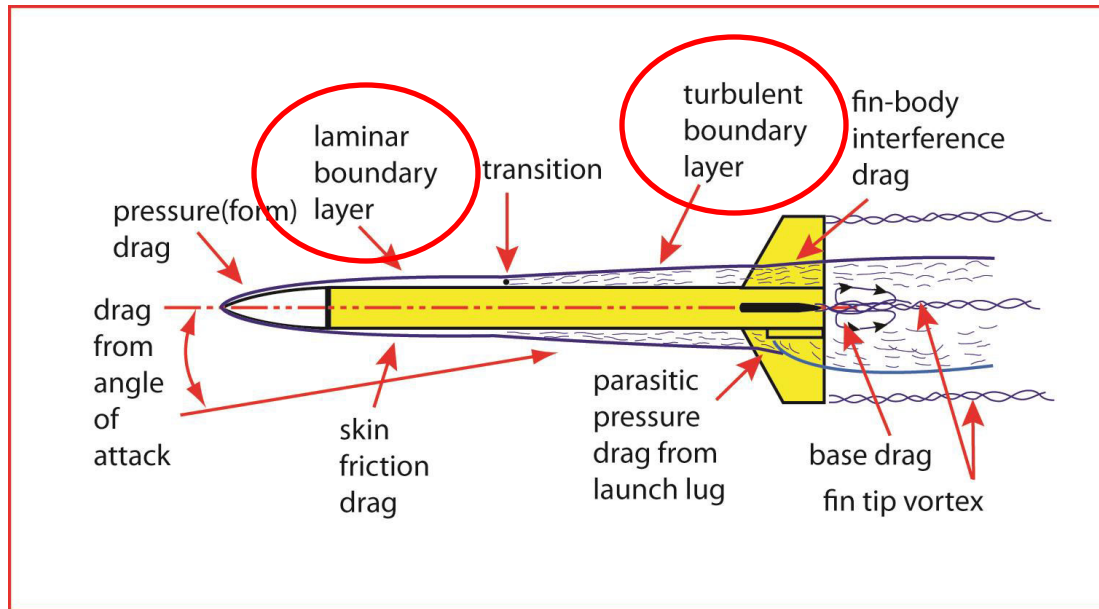

Aerodynamic Forces

- The **point** in which a laminar boundary layer becomes turbulent is called the **transition**.

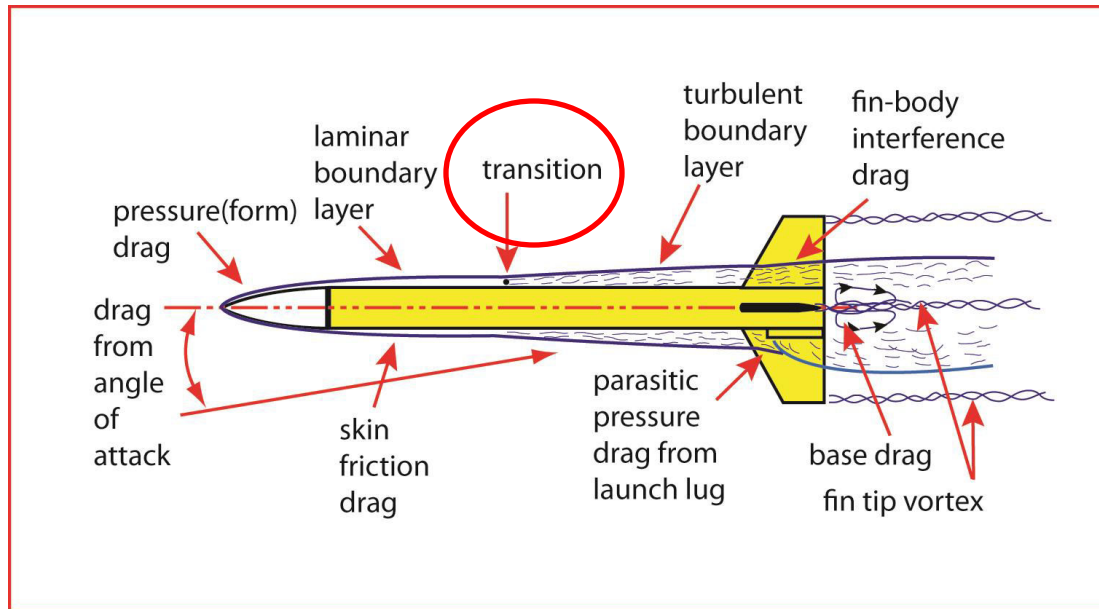

Aerodynamic Forces

- **Drag** is also **aerodynamic resistance** to the motion of the object through the fluid. This source of drag depends on the **shape** of the rocket and is called **pressure or form drag**.

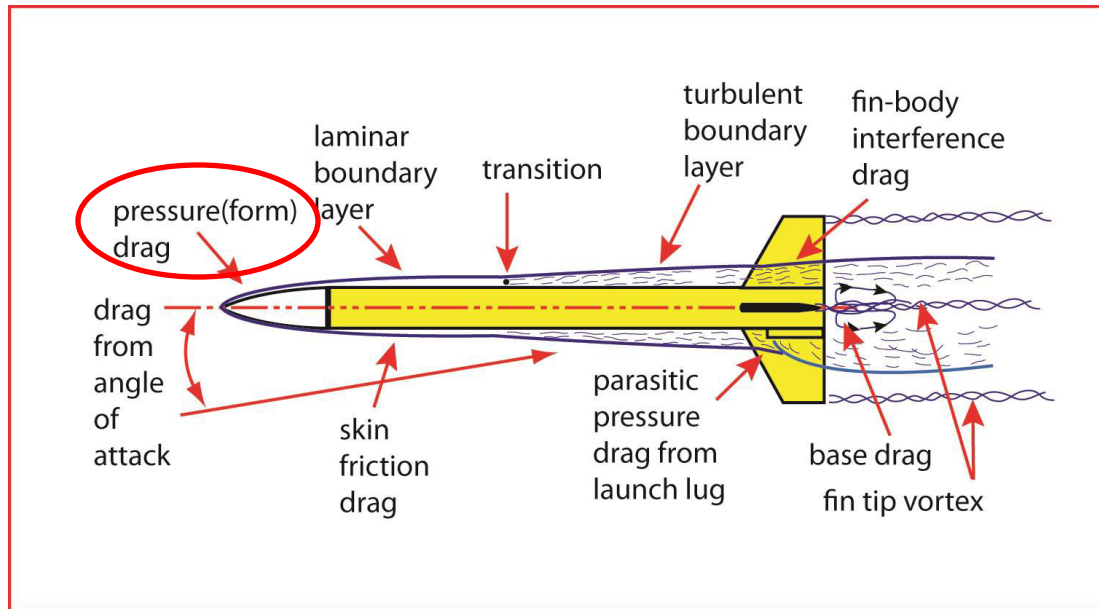

Aerodynamic Forces

- **Interference drag** occurs whenever two surfaces meet at sharp angles, such as at the fin roots. Interference drag creates a **vortex** which creates drag. Fin fillets reduce the effects of this drag.

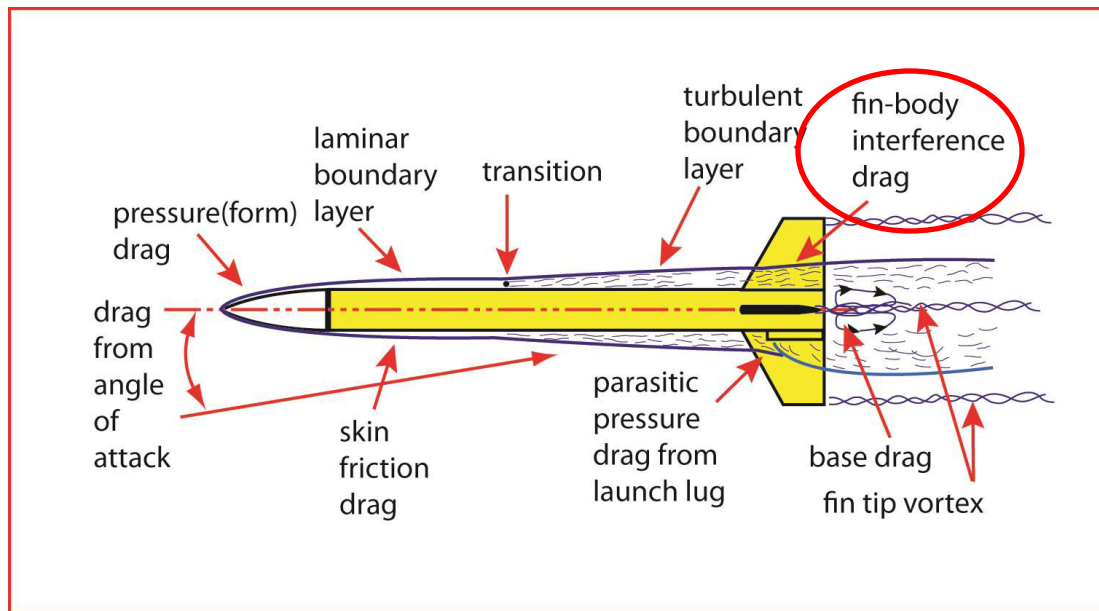

Aerodynamic Forces

- Air passing by the tips of the fins form a **fin tip vortex**. Accelerating the air into this vortex causes **drag** on the fins, and a **low** pressure area behind them. Tapered fin tips reduce this drag.

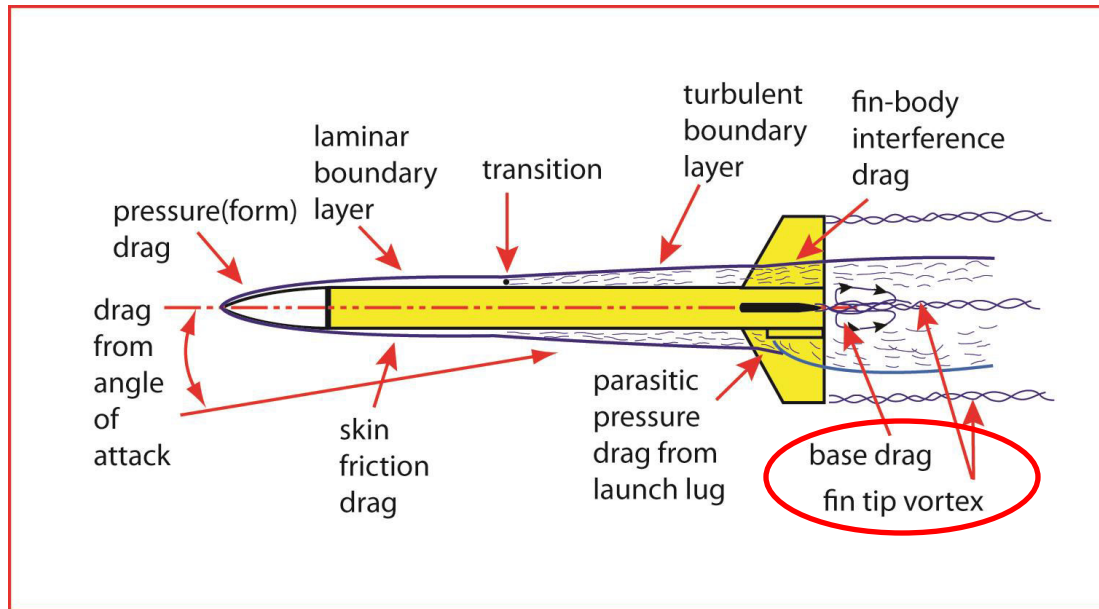

Aerodynamic Forces

- **Parasitic Drag** is produced by objects like the launch lug. The launch lug can account for **30%** of all drag. Cutting the lug's leading edge to 45 degrees reduces drag.

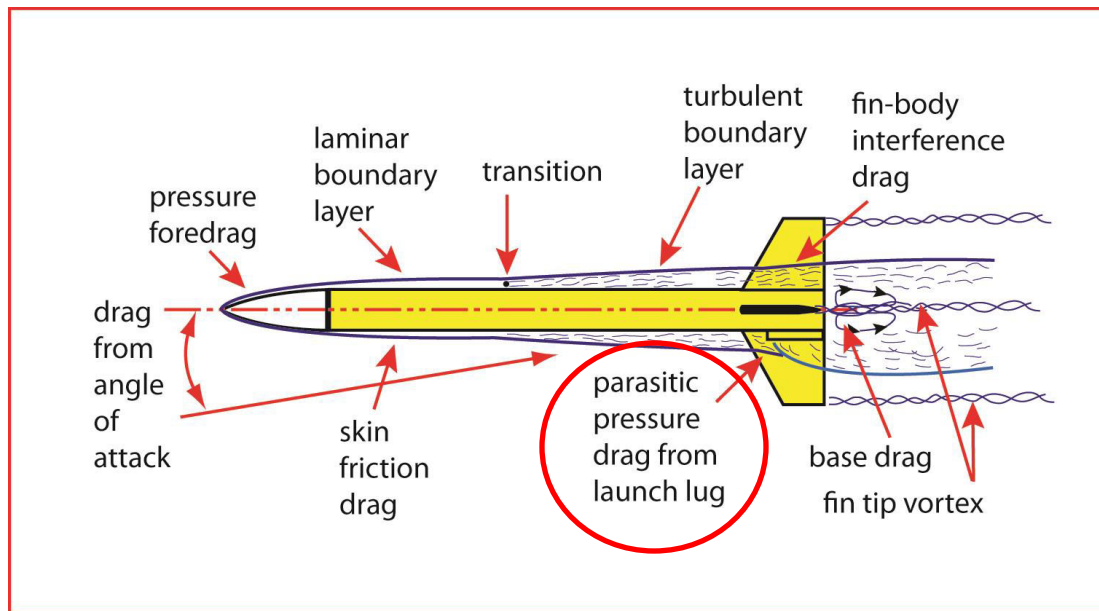

Airfoil Fins

- A model rocket's fin that is **square** on the edges creates a lot of **drag** and **turbulence**.
- If the fin's leading and trailing edges are sanded in a **round shape**, called an **airfoil**, it reduces the drag.

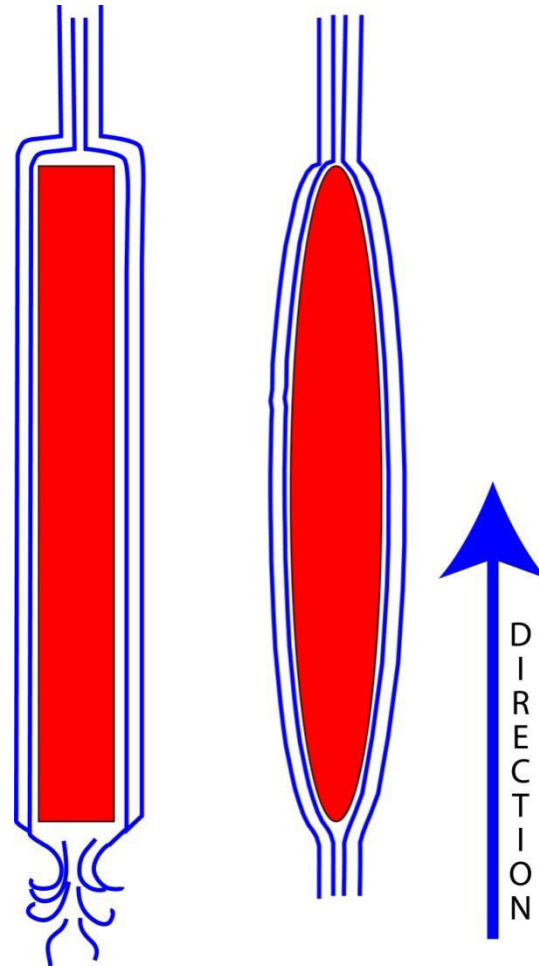

Airfoil Fins

- **airfoil shape fins** creates high pressure behind the fin and **pushes it forward**, cancelling out most of the pressure drag caused by the fins. This is called **pressure recovery**.

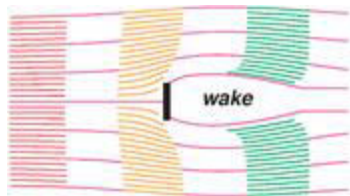

copyright © 1998 jst

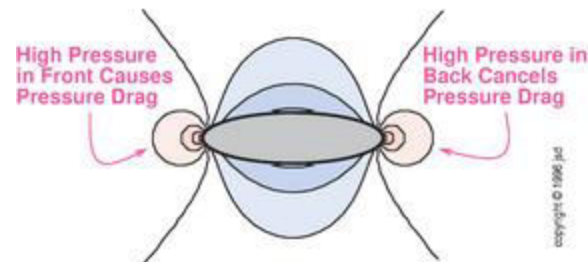
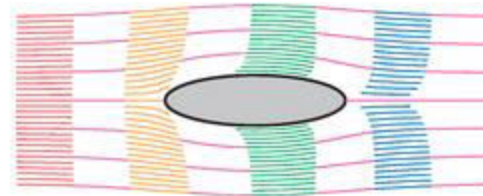

copyright © 1998 jst

Weight

- Weight is the force generated by the **gravitational** attraction on the rocket.
- The gravitational force is a **field force**; the source of the force does **not** have to be in physical contact with the object.
- Gravity affects the rocket whether it is **stationary** or **moving** (up or down).

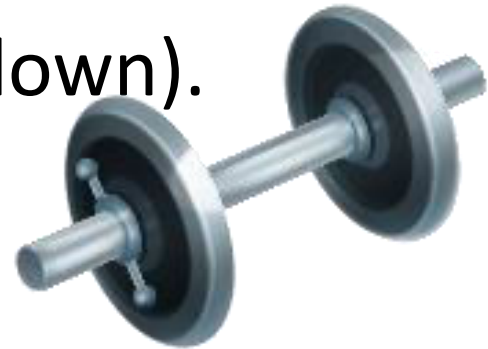

Thrust

- **Thrust** is the force applied to the rocket to **move it** through the air, and through space.
- **Thrust** is generated by the **propulsion system** of the rocket through the application of Newton's Third Law of Motion.
- The direction of the thrust is normally along the **longitudinal** axis of the rocket through the rocket's **center of gravity**.

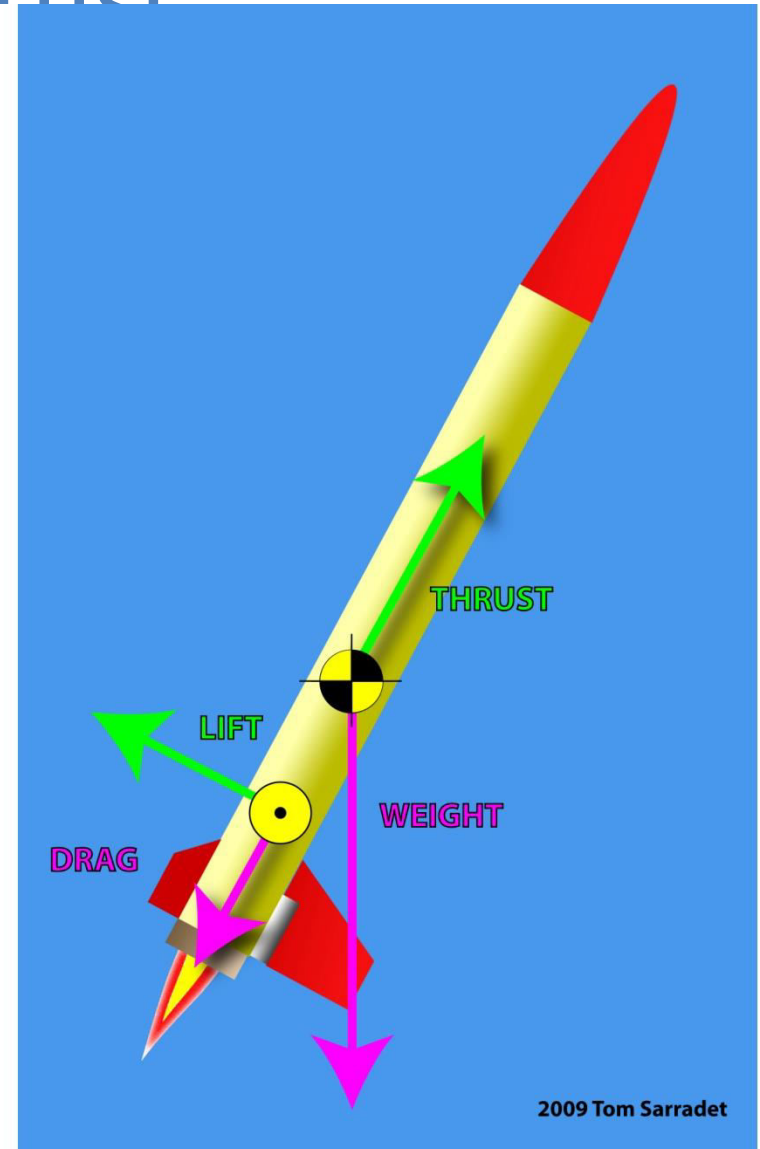

The Four Forces of Flight

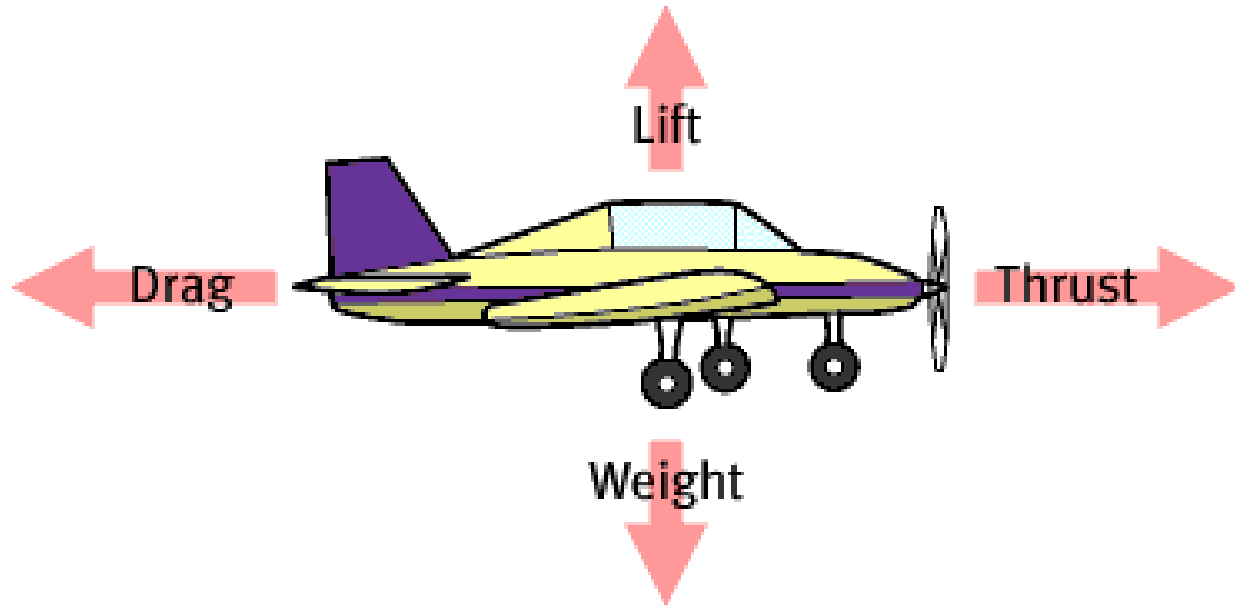

The four forces act on the airplane in flight and also work against each other.

The Four Forces of Flight

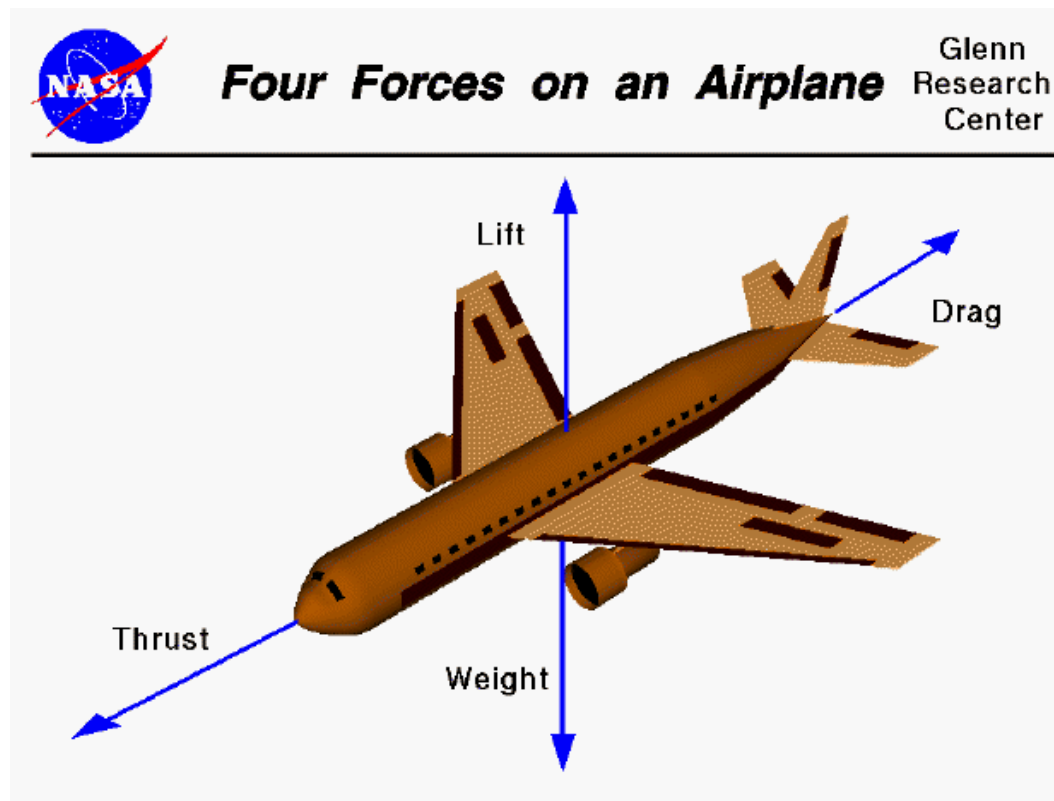

The four forces act on the airplane in flight and also work against each other.



What is Weight?

Glenn
Research
Center

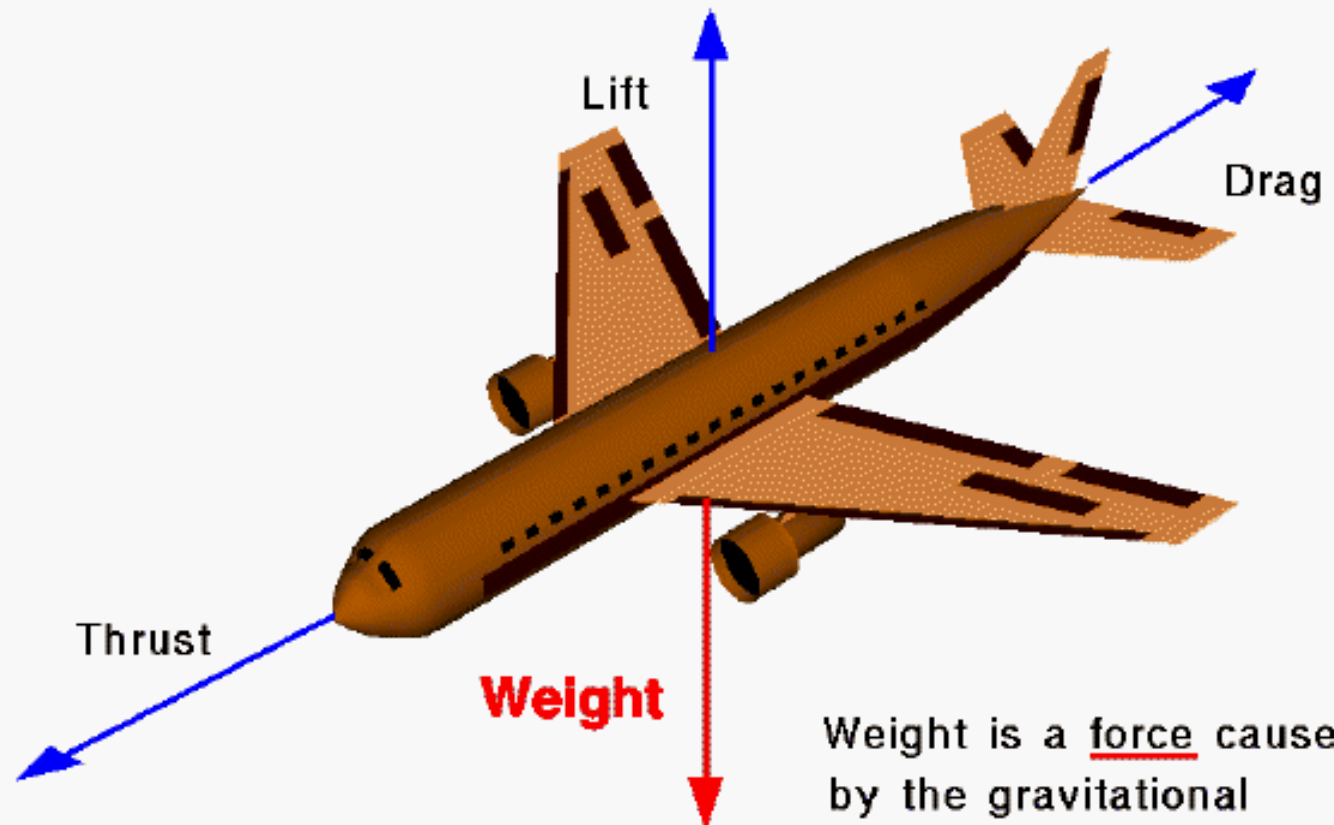

Weight is a force caused by the gravitational attraction of the Earth.

The earth's gravity pulls down on objects and gives them weight.

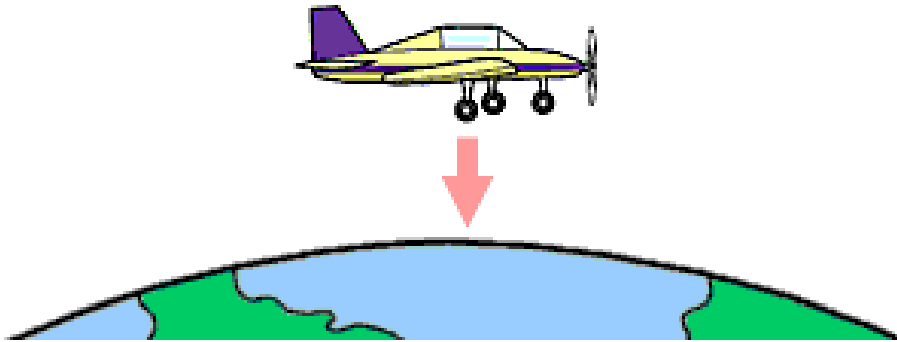

Weight counteracts lift.

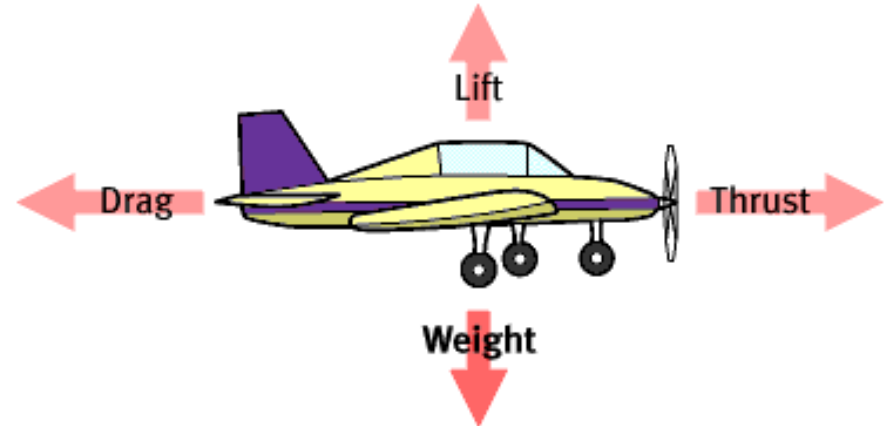

What's it take to create lift?

Air and motion.

How do we explain lift?

Newton's Laws of Motion and Bernoulli's Principle are used to explain lift.



Daniel Bernoulli



Sir Isaac Newton

Newton's Second Law: force causes a change in velocity which in turn generates another force.

Newton's Third Law: net flow of air is turned down resulting in an 'equal and opposite' upward force.



Lift from Flow Turning

Glenn
Research
Center



Lift is a force.

Newton's Third Law states that for every action there is an equal and opposite reaction.

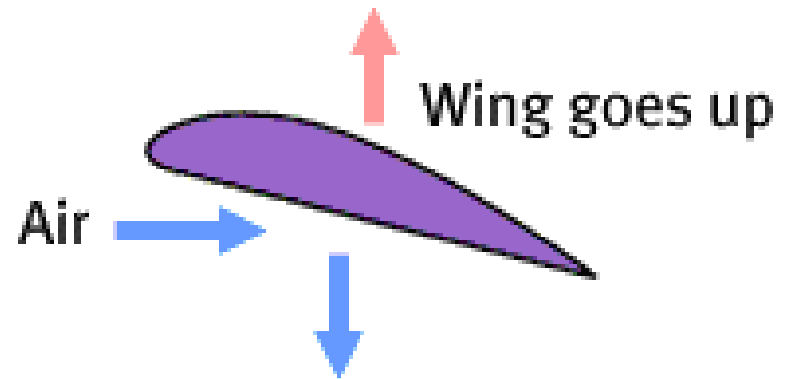
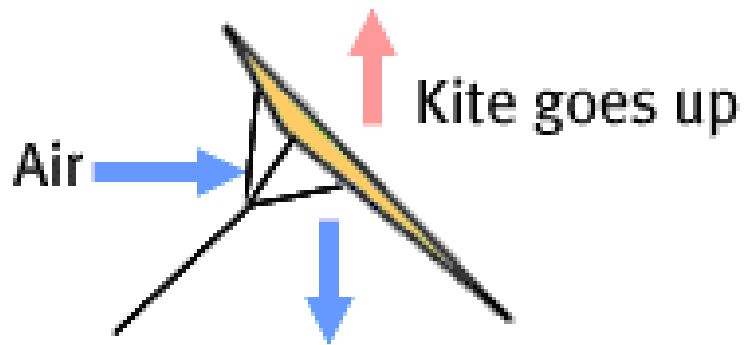



Shape Effects on Lift

Glenn
Research
Center

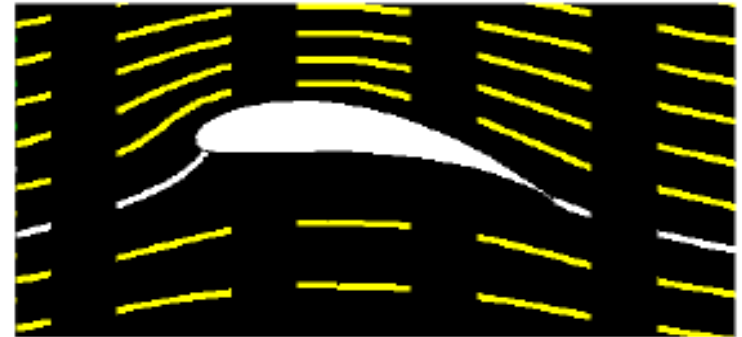
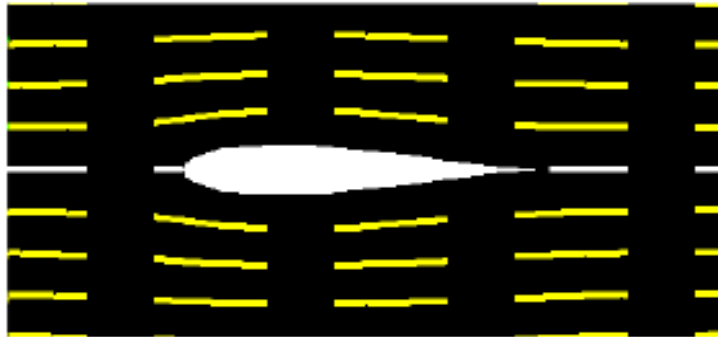

Flow turning at trailing edge is very important.

Higher Turning = Greater Lift

This effect is used for stability and control of the airplane.

Included in Lift Coefficient

<http://www.grc.nasa.gov/WWW/Wright/airplane/shape.html>

A wing creates lift due to a combination of Bernoulli's Principal & Newton's Third Law

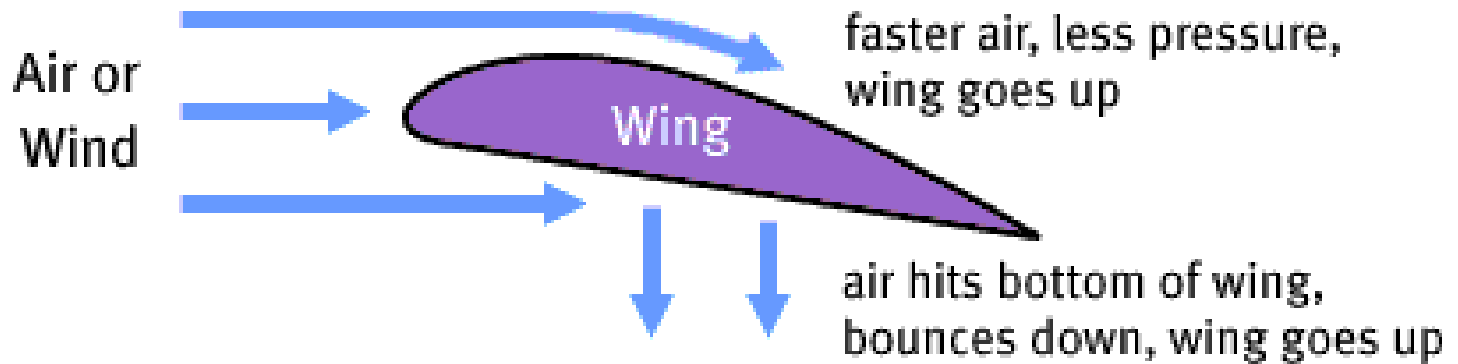



What is Drag?

Glenn
Research
Center

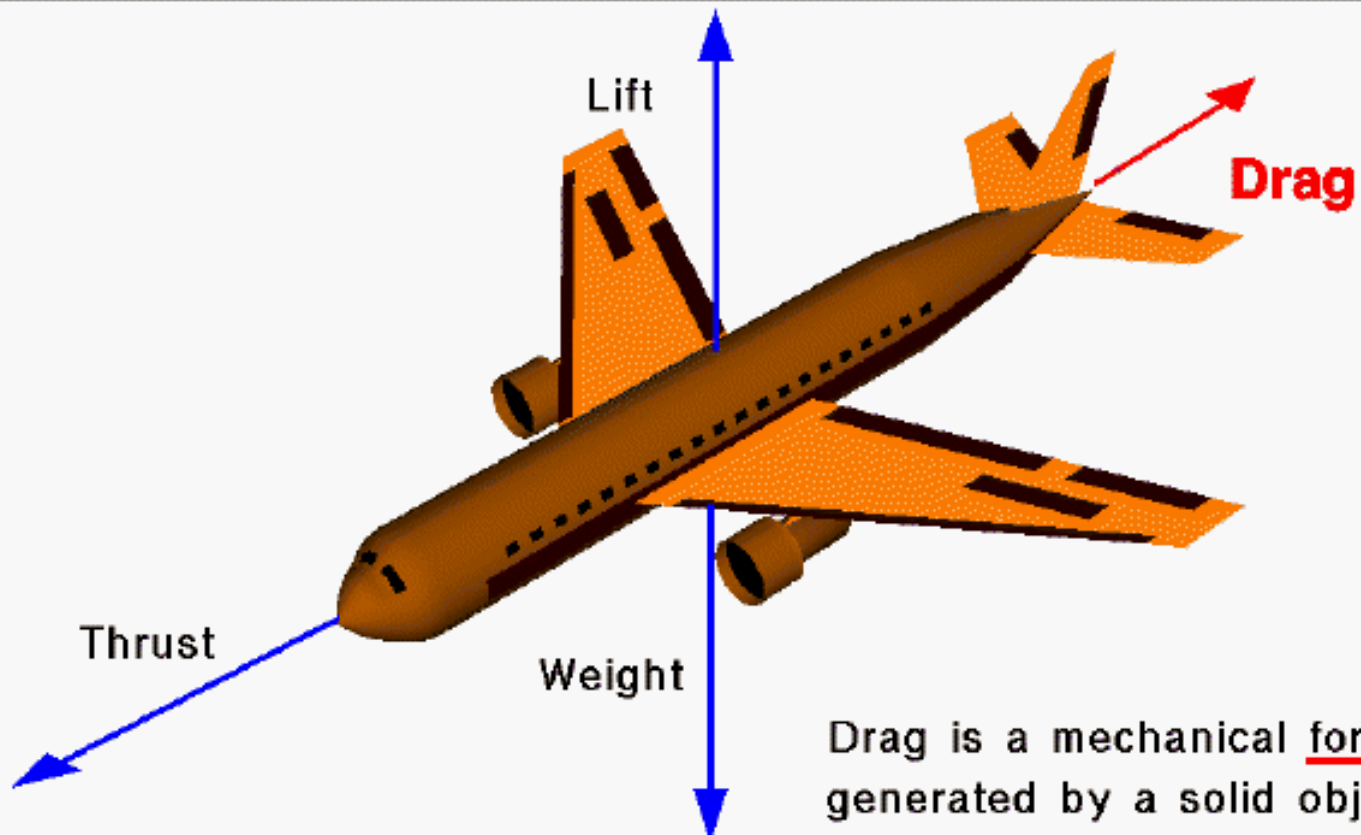

Drag is a mechanical force generated by a solid object moving through a fluid.

Drag is the force of resistance an aircraft 'feels' as it moves through the air.

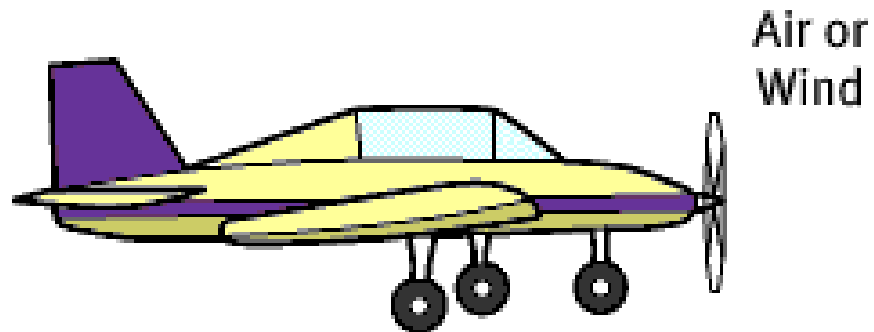

For an airplane to take off, lift must be greater than weight.

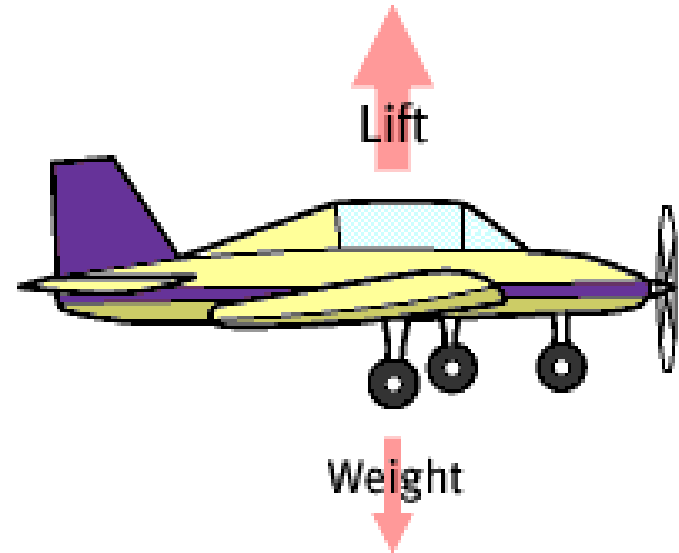

For an airplane to speed up while flying, thrust must be greater than drag.

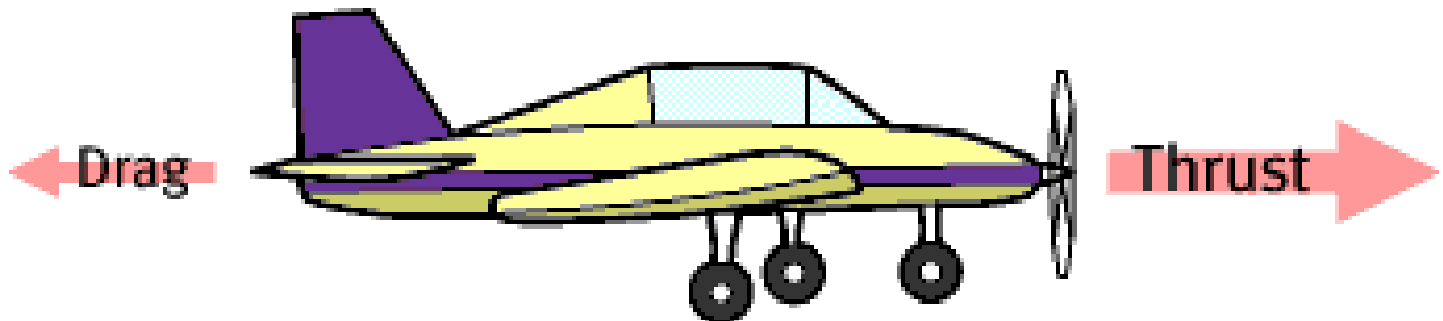

Engines (either jet or propeller) typically provide the thrust for aircraft. When you fly a paper airplane, you generate the thrust.



→
Propeller



→
Jet Engine



→
Hand

A propeller is a spinning wing that generates lift forward.

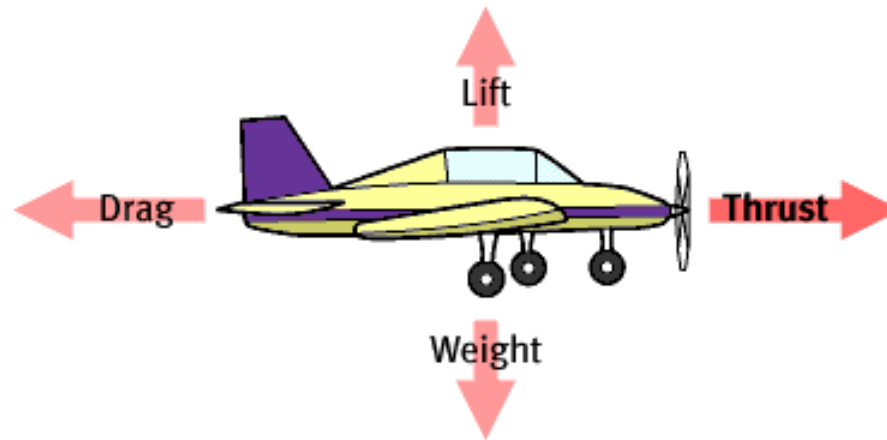



Propeller Propulsion

Glenn
Research
Center



P-51 Mustang

Wind Tunnel Test





Airplane Parts Definitions

Glenn
Research
Center

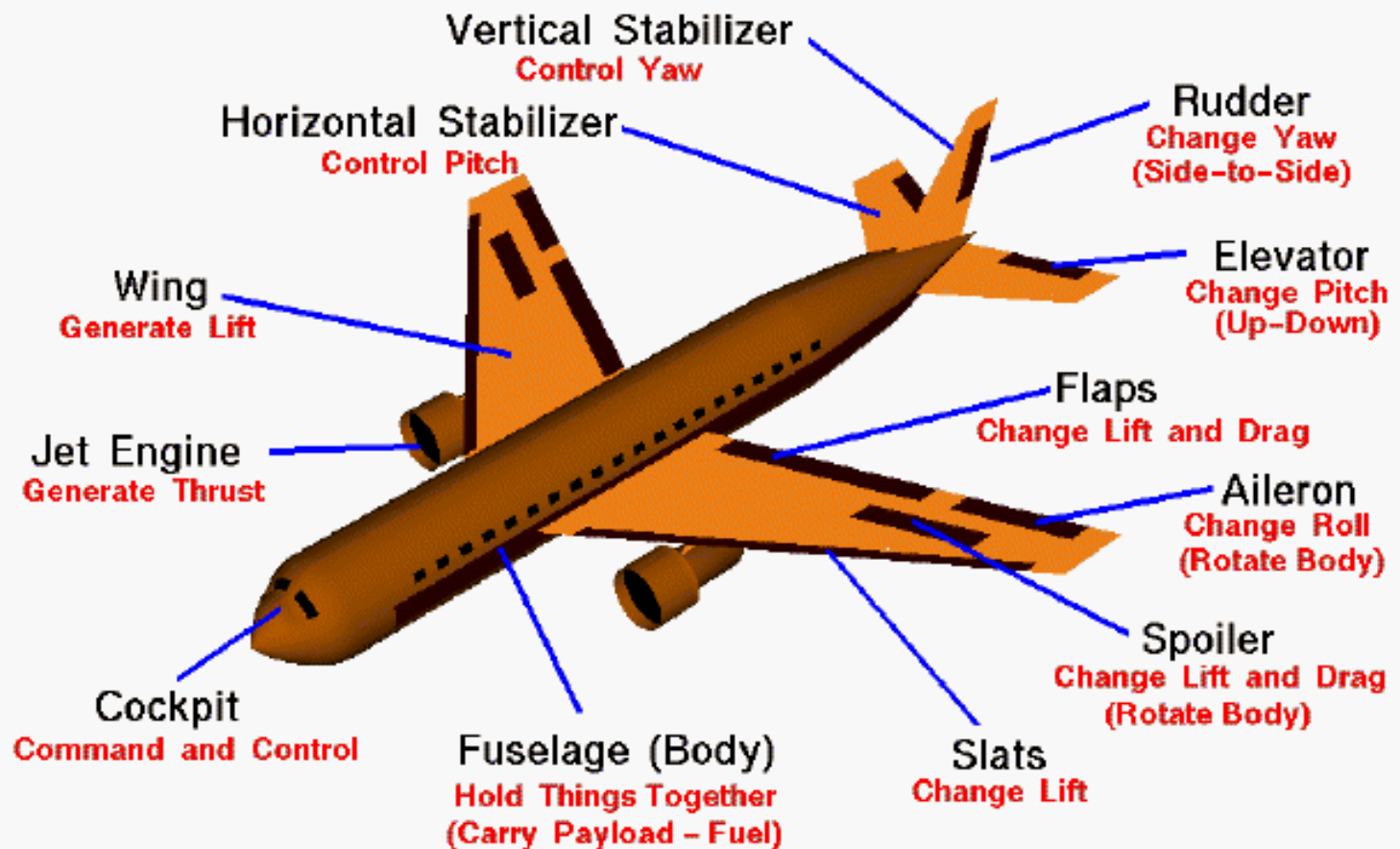

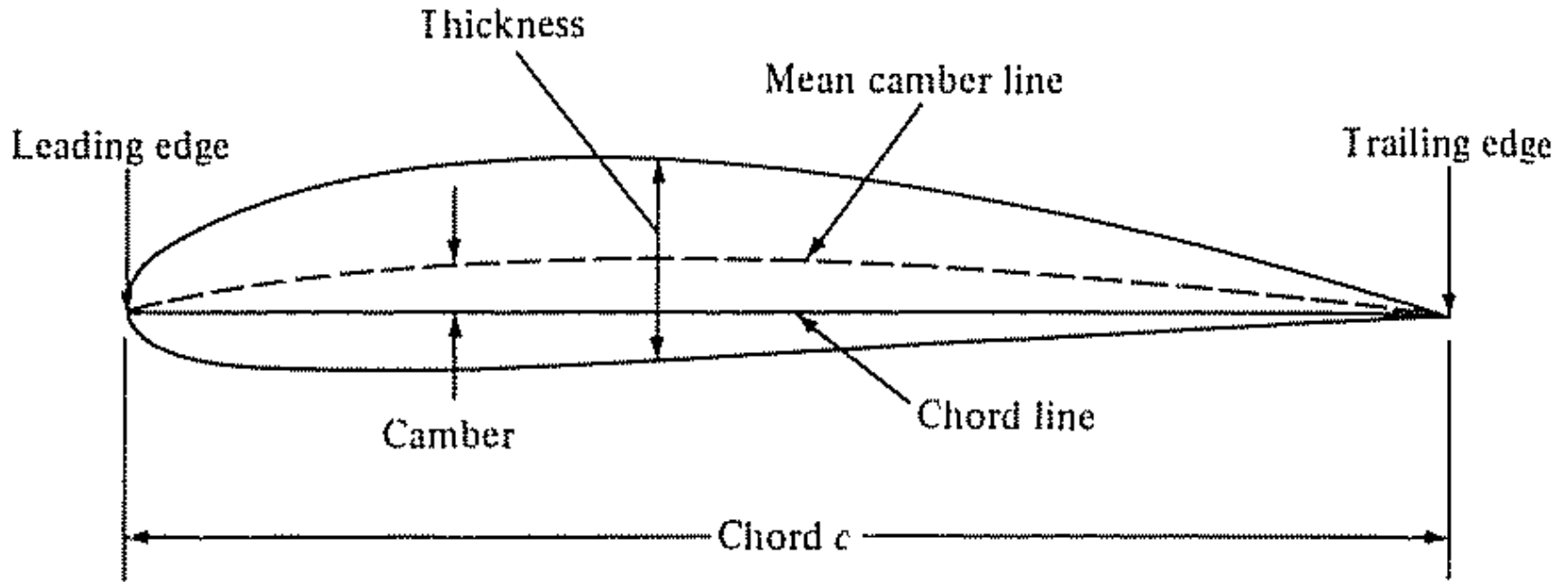

- **Mean Chamber Line:** Set of points halfway between upper and lower surfaces
 - Measured perpendicular to mean chamber line itself
- **Leading Edge:** Most forward point of mean chamber line
- **Trailing Edge:** Most reward point of mean chamber line
- **Chord Line:** Straight line connecting the leading and trailing edges
- **Chord, c:** Distance along the chord line from leading to trailing edge
- **Chamber:** Maximum distance between mean chamber line and chord line
 - Measured perpendicular to chord line

NACA FOUR-DIGIT SERIES

- First set of airfoils designed using this approach was NACA Four-Digit Series
- **First digit** specifies maximum camber in percentage of chord
- **Second digit** indicates position of maximum camber in tenths of chord
- **Last two digits** provide maximum thickness of airfoil in percentage of chord

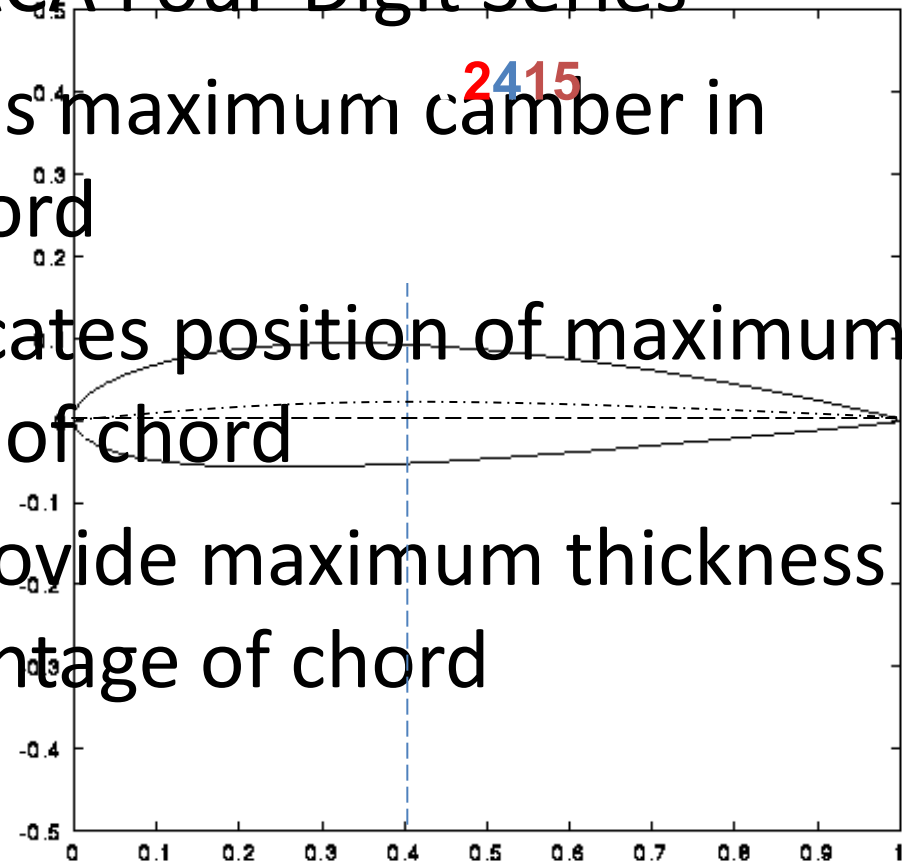

English Sopwith Camel AIRFOIL THICK

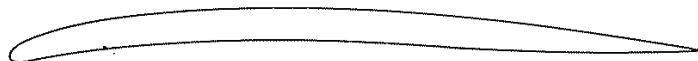

RAF 14. British

Thin wing, lower maximum C_L
Bracing wires required – high drag



German Fokker Dr-1

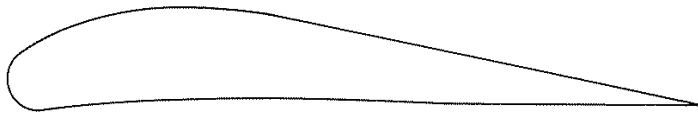

Göttingen 298. German

Higher maximum C_L
Internal wing structure
Higher rates of climb
Improved maneuverability



STREAMLINE FLOW PATTERNS

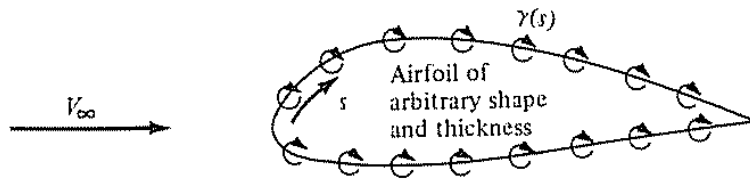
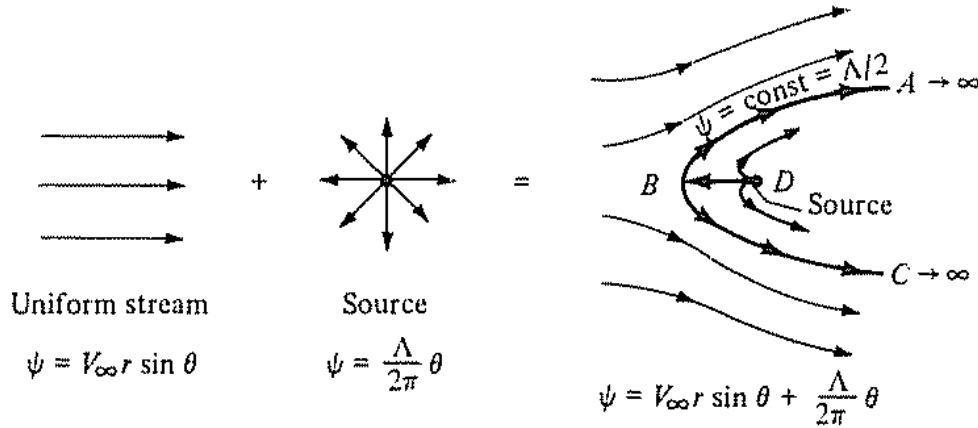
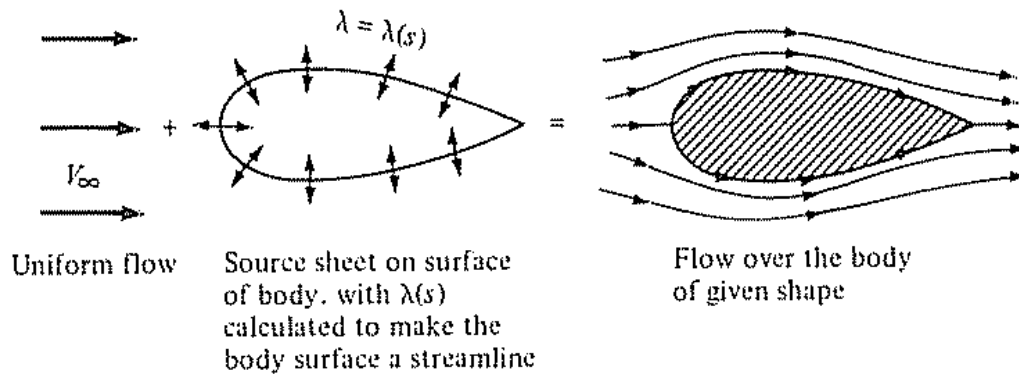

Figure 4.10 Simulation of an arbitrary airfoil by distributing a vortex sheet over the airfoil surface



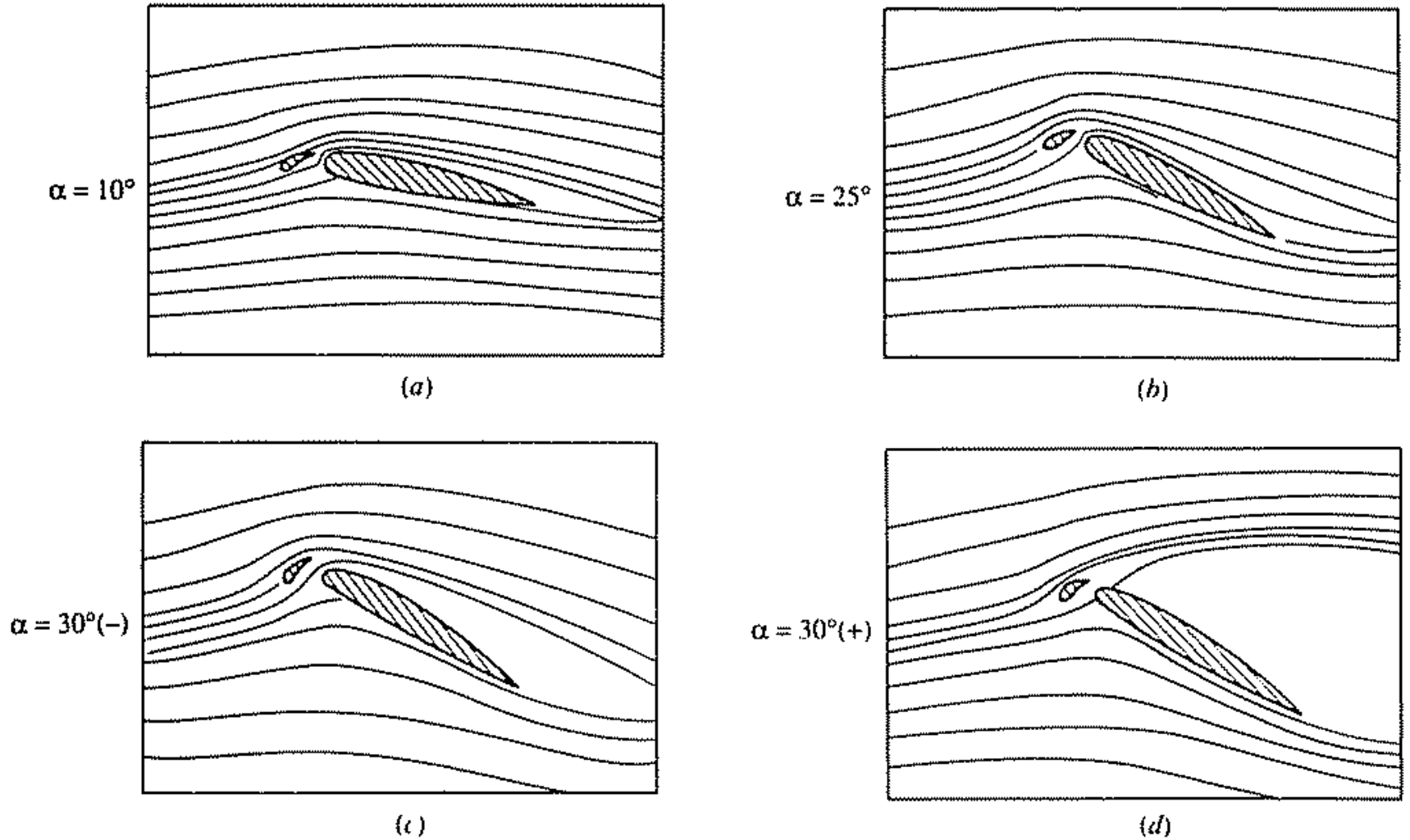
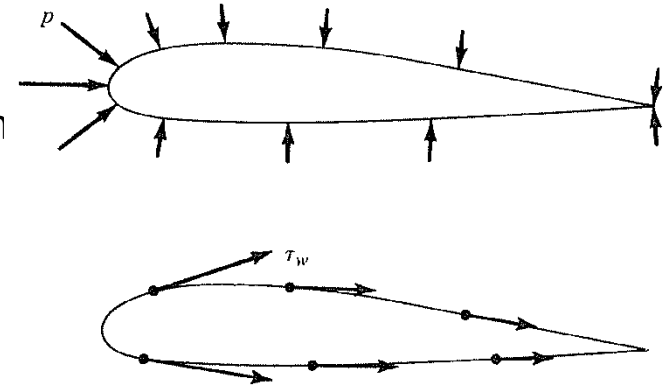

Figure 4.41 Effect of a leading-edge slat on the streamline pattern over an NACA 4412 airfoil
(The streamlines are drawn to scale from the experimental data in Reference 50)

WHAT CREATES AERODYNAMIC FORCES?

- Aerodynamic forces exerted by airflow comes from
- **Pressure, p** , distribution on surface
 - Acts normal to surface
- **Shear stress, τ_w** , (friction) on surface
 - Acts tangentially to surface
- Pressure and shear are in units of force per unit area (N/m^2)
- Net unbalance creates an aerodynamic force



“No matter how complex the flow field, and no matter how complex the shape of the body, the only way nature has of communicating an aerodynamic force to a solid object or surface is through the pressure and shear stress distributions that exist on the surface.”

“The pressure and shear stress distributions are the two hands of nature that reach out and grab the body, exerting a force on the body – the aerodynamic force”

RESOLVING THE AERODYNAMIC FORCE

- **Relative Wind:** Direction of V_∞
 - We used subscript ∞ to indicate far upstream conditions
- **Angle of Attack, α :** Angle between relative wind (V_∞) and chord line
- Total aerodynamic force, **R**, can be resolved into two force components
- **Lift, L:** Component of aerodynamic force perpendicular to relative wind
- **Drag, D:** Component of aerodynamic force parallel to relative wind

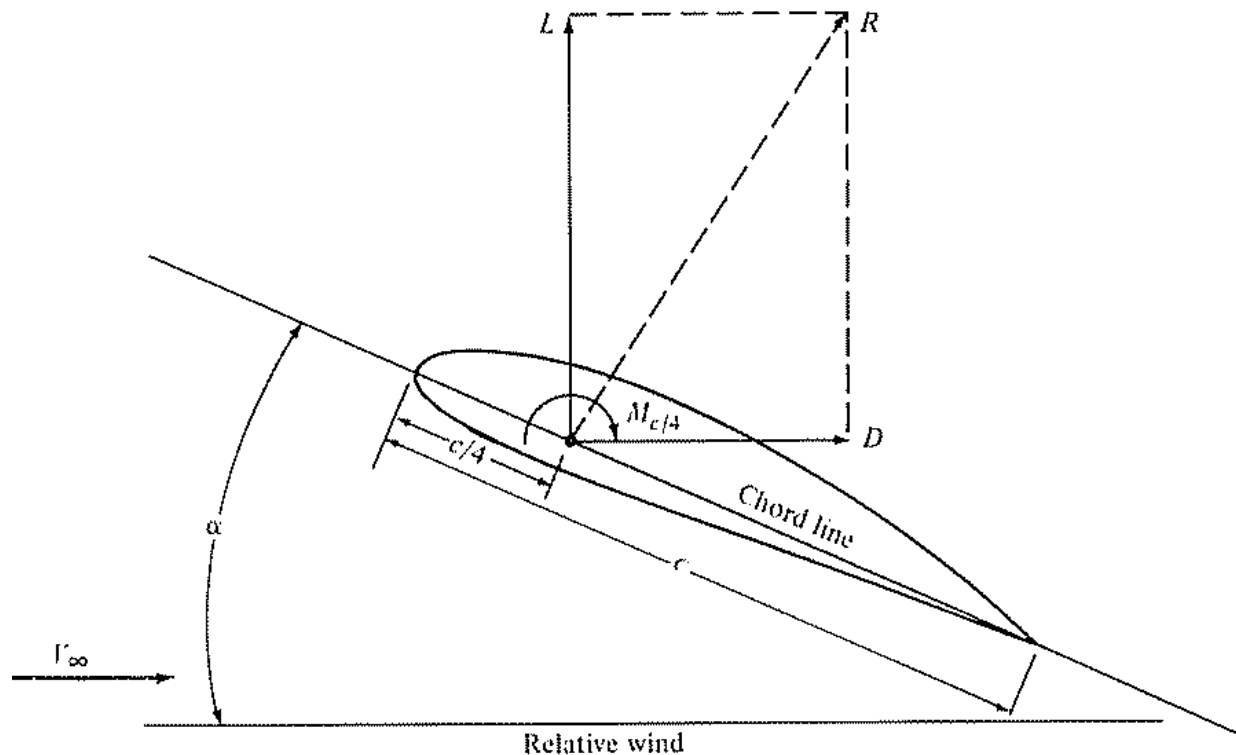

RESOLVING THE AERODYNAMIC FORCE

- Aerodynamic force, R , may also be resolved into components perpendicular and parallel to chord line
 - Normal Force, N : Perpendicular to chord line
 - Axial Force, A : Parallel to chord line
- L and D are easily related to N and A
- For airfoils and wings, L and D most common
- For rockets, missiles, bullets, etc. N and A more useful

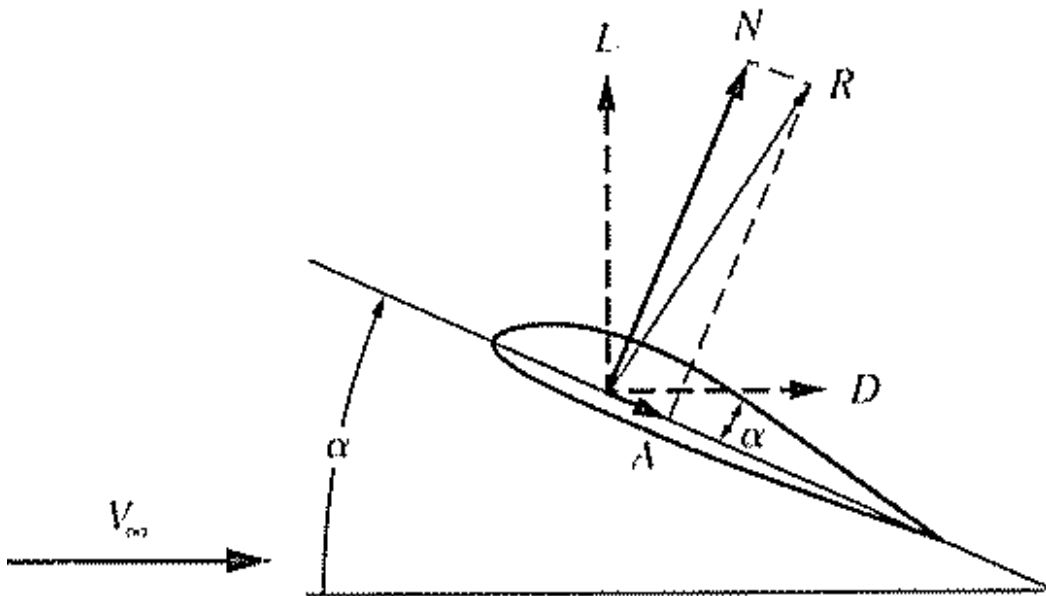

$L =$
 $D =$

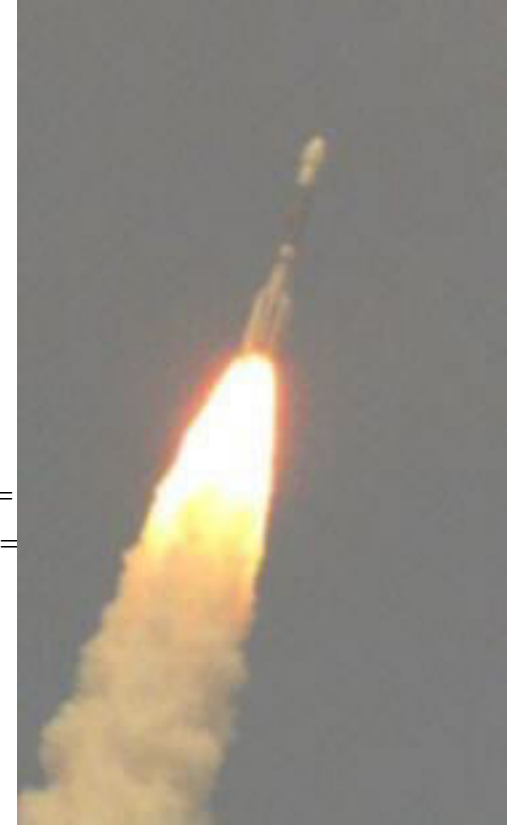

AERODYNAMIC MOMENT

- Total aerodynamic force on airfoil is summation of F_1 and F_2
- Lift is obtained when $F_2 > F_1$
- Misalignment of F_1 and F_2 creates Moments, M , which tend to rotate airfoil/wing
- Value of induced moment depends on point about which moments are taken
 - Moments about leading edge, MLE or quarter-chord point, $c/4$, $M_{c/4}$
 - In general $M_{LE} \neq M_{c/4}$

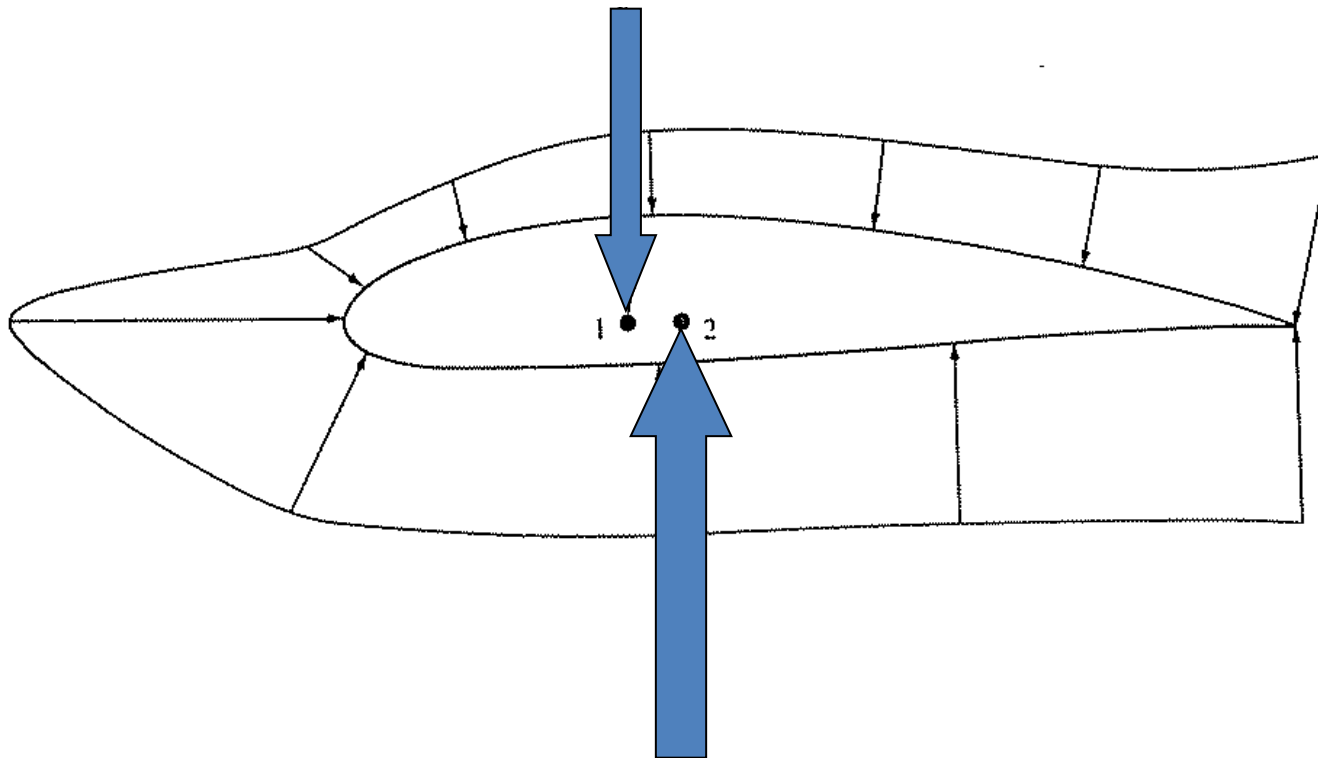

VARIATION OF L, D, AND M WITH α

- Lift, Drag and M on a airfoil or wing will change as α changes
- Variations of these quantities are some of most important information that an airplane designer needs to know
- **Aerodynamic Center**
 - Point about which moments essentially do not vary with α
 - M_{ac} =constant (independent of α)
 - For low speed airfoils aerodynamic center is near quarter-chord point

HOW DOES AN AIRFOIL GENERATE LIFT?

- Lift due to imbalance of pressure distribution over top and bottom surfaces of airfoil (or wing)
 - If pressure on top is lower than pressure on bottom surface, lift is generated
 - Why is pressure lower on top surface?
- We can understand answer from basic physics:
 - Continuity (Mass Conservation)
 - Newton's 2nd law (Euler or Bernoulli Equation)



HOW DOES AN AIRFOIL GENERATE LIFT?

1. Flow velocity over top of airfoil is faster than over bottom surface
 - Streamtube A senses upper portion of airfoil as an obstruction
 - Streamtube A is squashed to smaller cross-sectional area
 - Mass continuity $\rho AV = \text{constant}$: IF $A \downarrow$ THEN $V \uparrow$

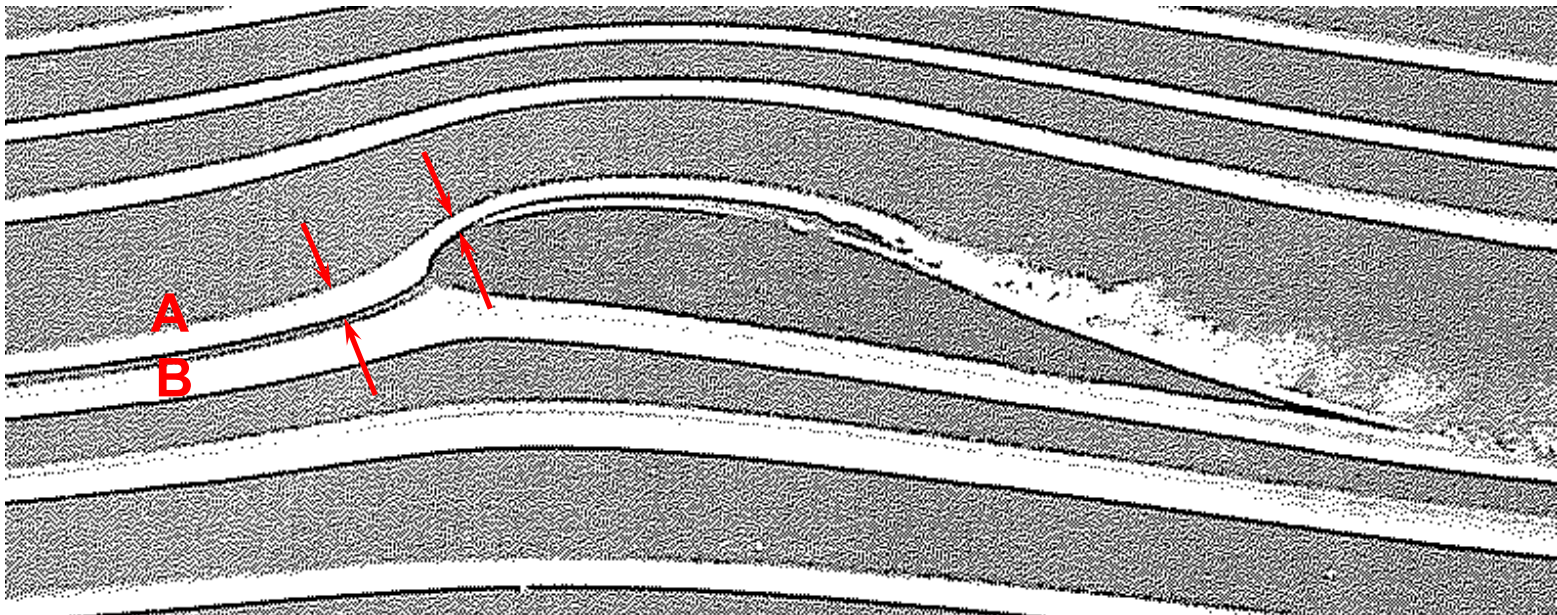
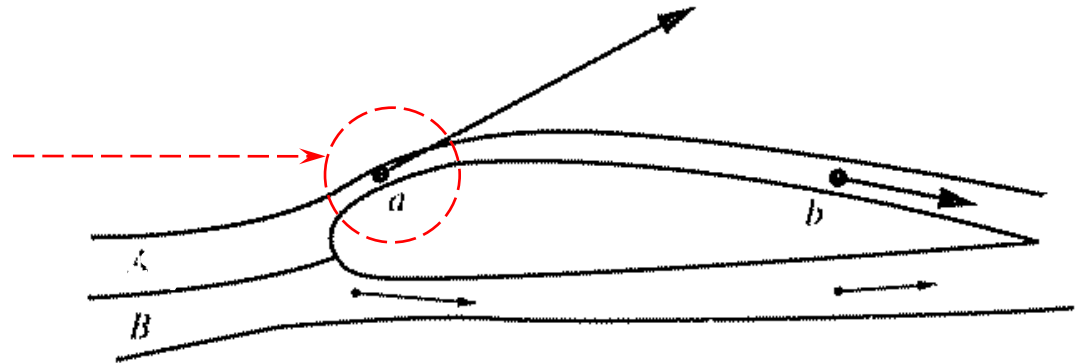

HOW DOES AN AIRFOIL GENERATE LIFT?

2. As $V \uparrow$ $p \downarrow$

$$p + \frac{1}{2} \rho V^2 = \text{constant}$$

– Incompressible: Bernoulli's Equation

$$dp = -\rho V dV$$

– Compressible: Euler's Equation

– Called **Bernoulli Effect**

3.

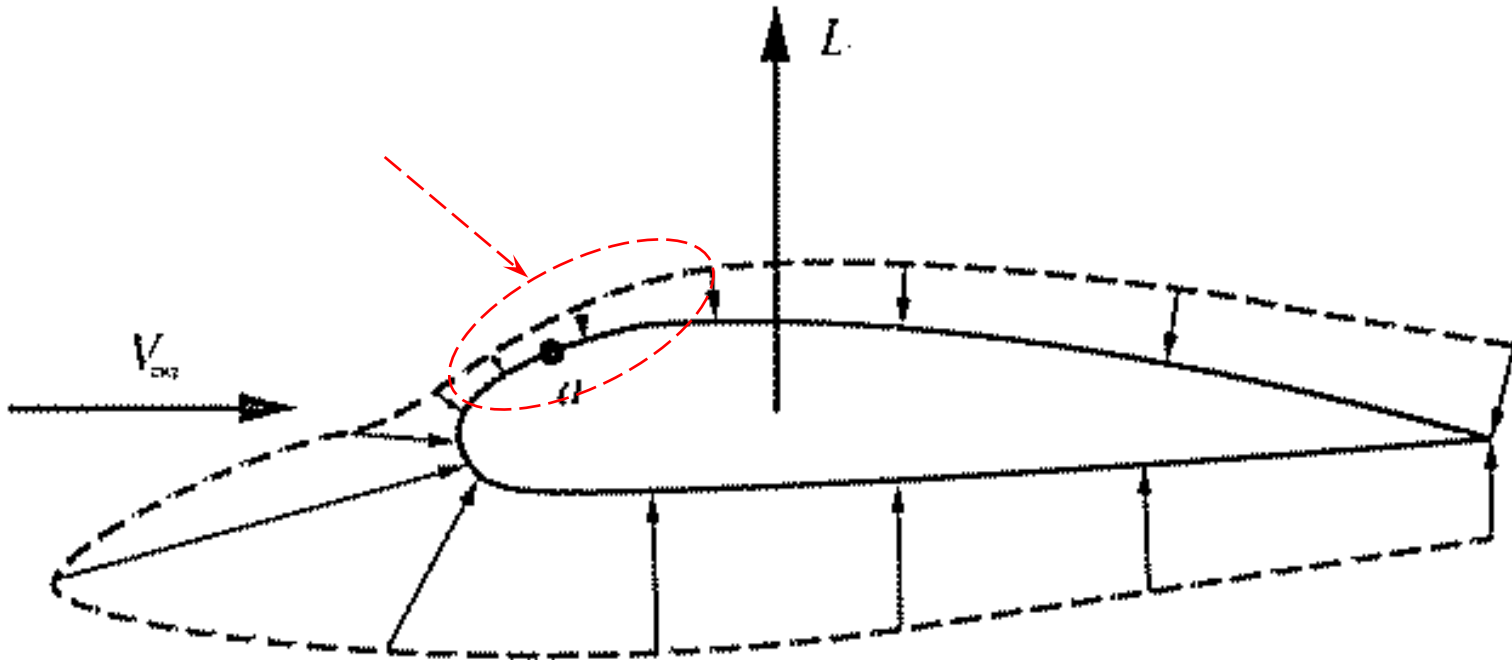

Is a

Can you express these ideas in your own words?

EVEN A FLAT PLATE WILL GENERATE LIFT

- Curved surface of an airfoil is not necessary to produce lift

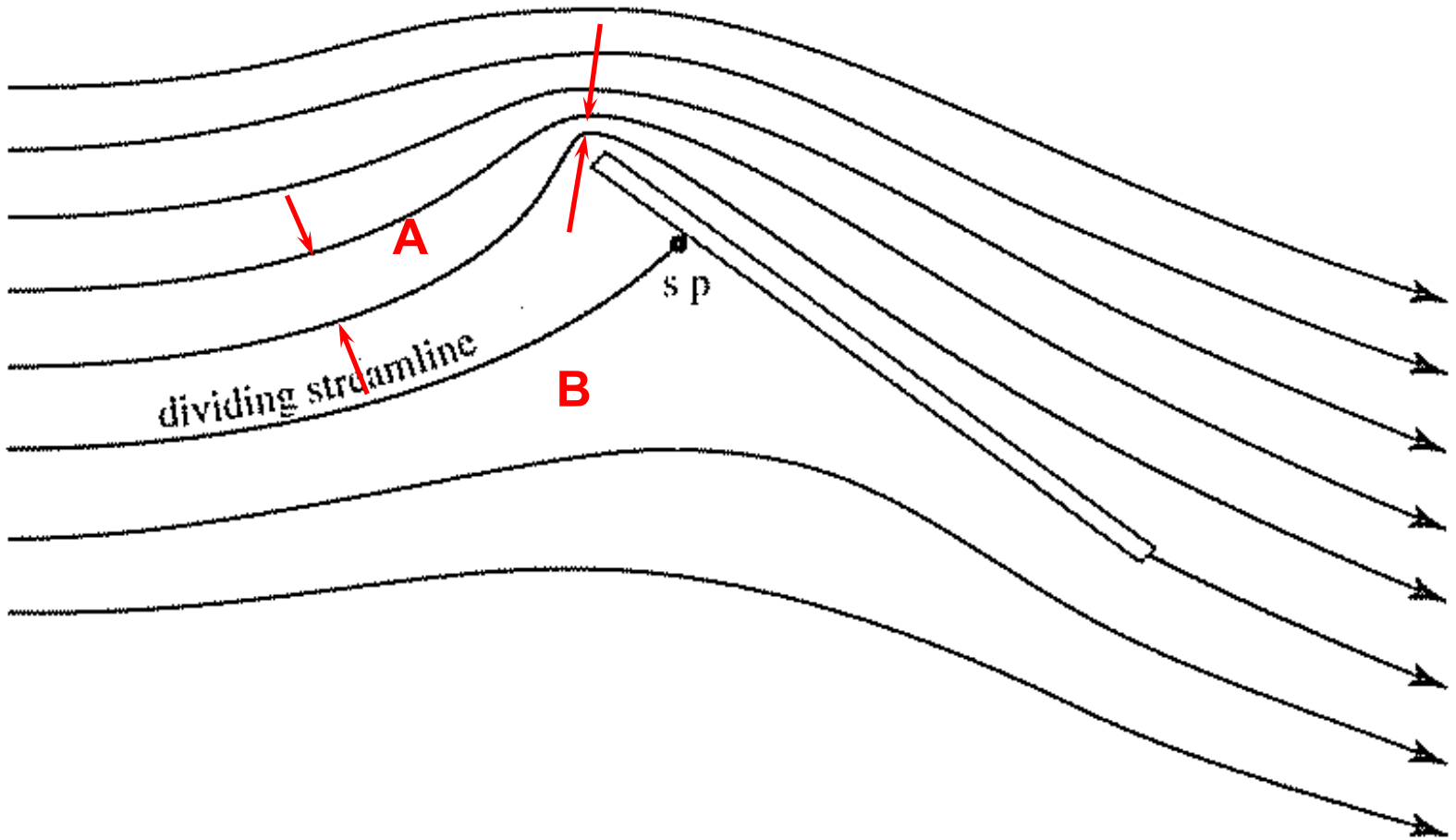

LIFT, DRAG, AND MOMENT COEFFICIENTS

- Behavior of L, D, and M depend on α , but also on velocity and altitude
 - V_∞ , ρ_∞ , Wing Area (S), Wing Shape, μ_∞ , compressibility
- Characterize behavior of L, D, M with coefficients (c_l , c_d , c_m)

$$L = \frac{1}{2} \rho V_\infty^2 S c_l$$

$$c_l \equiv \frac{L}{\frac{1}{2} \rho V_\infty^2 S} = \frac{L}{q_\infty S}$$

$$c_l = f(\alpha, M_\infty, \text{Re})$$

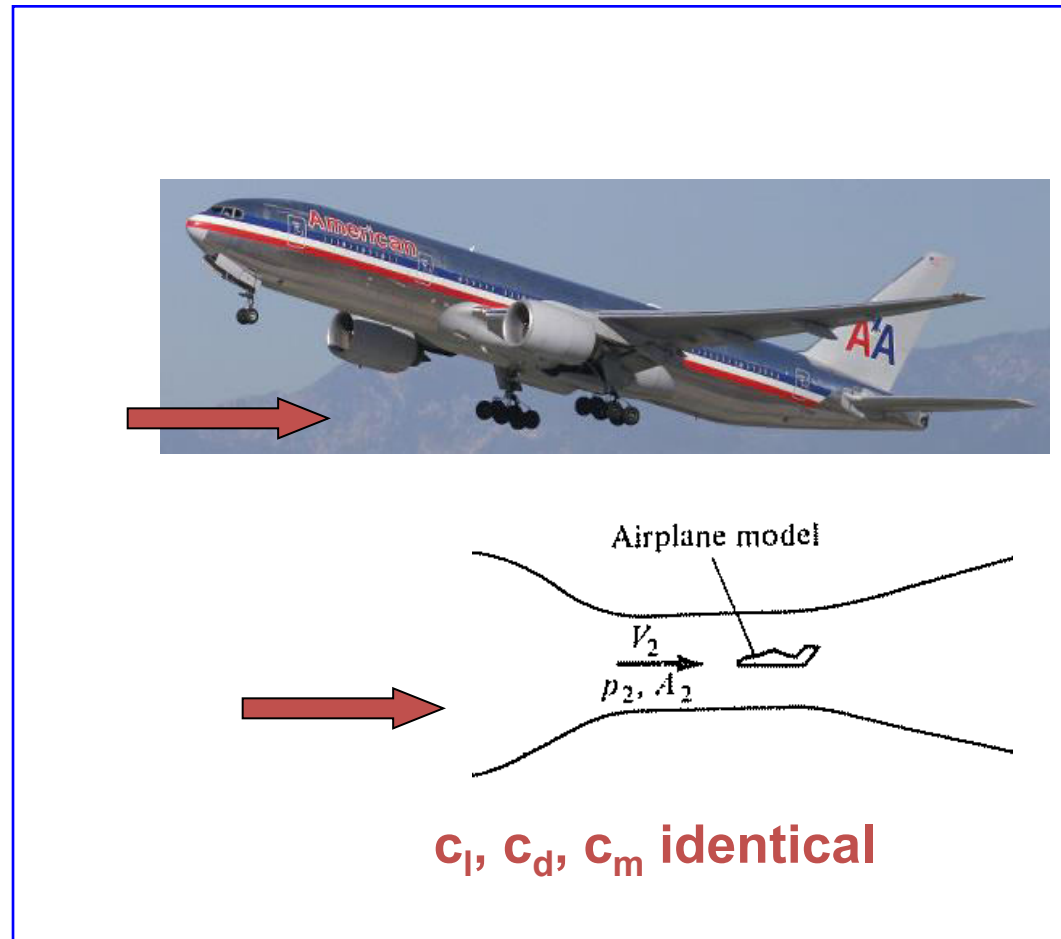

LIFT, DRAG, AND MOMENT COEFFICIENTS

- Behavior of L, D, and M depend on α , but also on velocity and altitude
 - V_∞ , ρ_∞ , Wing Area (S), Wing Shape, μ_∞ , compressibility
- Characterize behavior of L, D, M with coefficients (c_l , c_d , c_m)

$$L = \frac{1}{2} \rho V_\infty^2 S c_l$$

$$D = \frac{1}{2} \rho V_\infty^2 S c_d$$

$$M = \frac{1}{2} \rho V_\infty^2 S c_m$$

$$c_l \equiv \frac{L}{\frac{1}{2} \rho V_\infty^2 S} = \frac{L}{q_\infty S}$$

$$c_m \equiv \frac{M}{\frac{1}{2} \rho V_\infty^2 S} = \frac{M}{q_\infty S}$$

Note on Notation:

We use lower case, c_l , c_d , and c_m for infinite wings (airfoils)

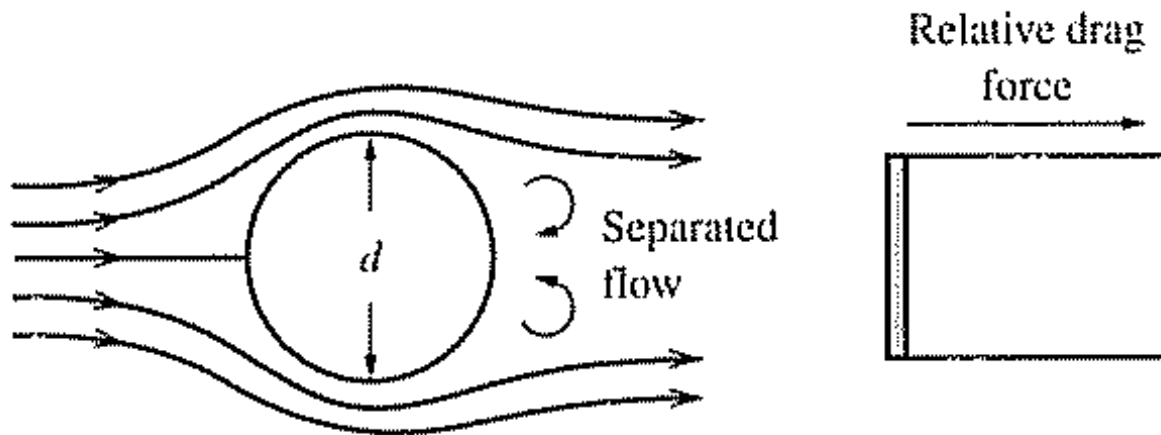

We use upper case, C_L , C_D , and C_M for finite wings

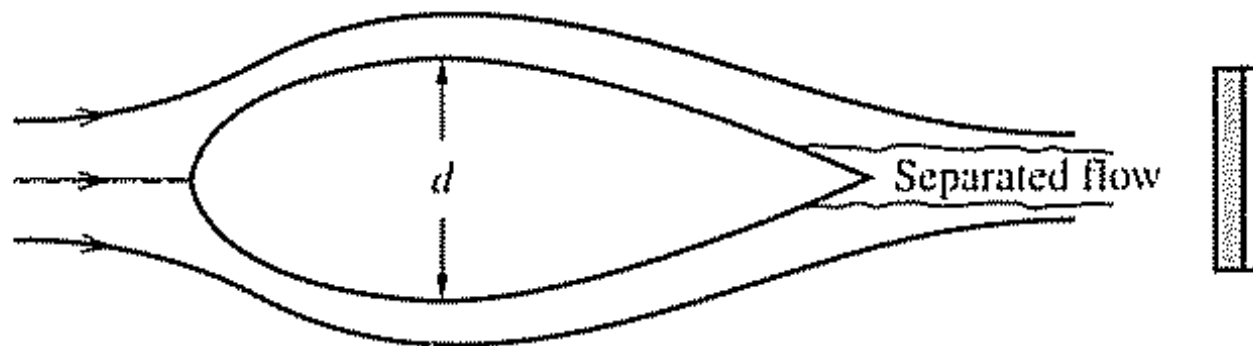

(a) Blunt body



(b) Streamlined body

Code	
	Skin friction drag
	Pressure drag

HYDRODYNAMICS

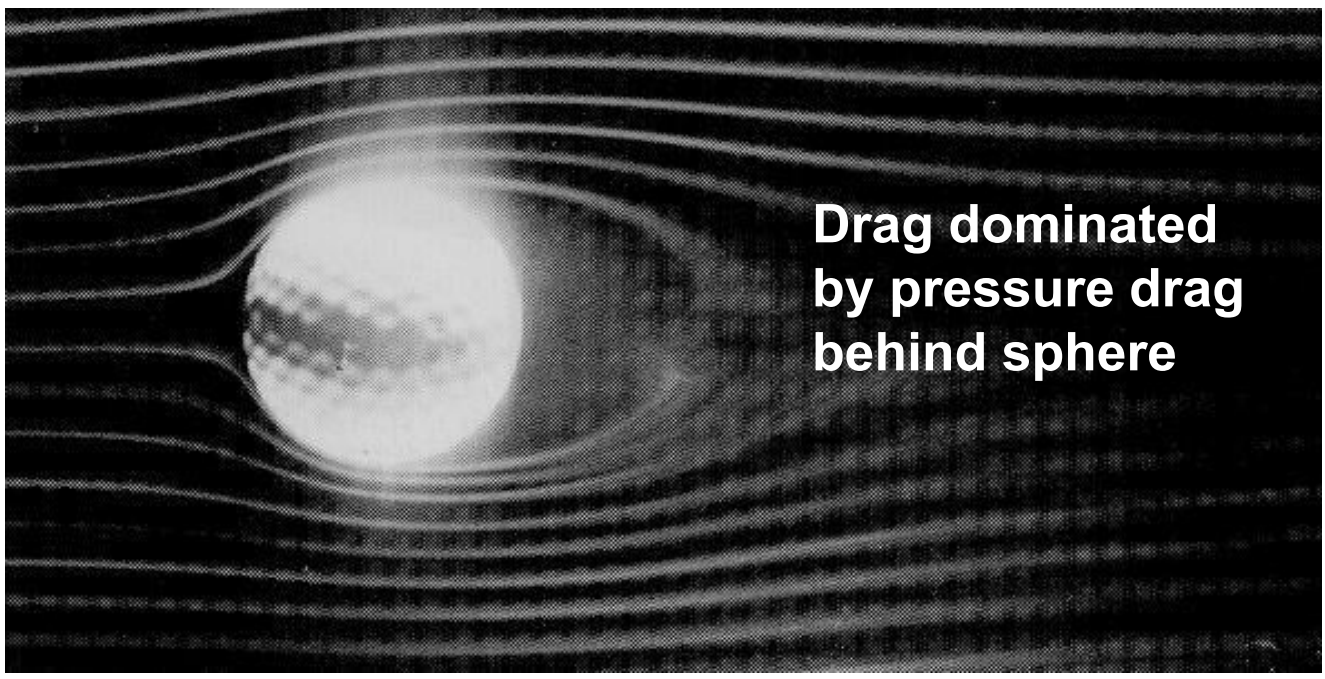
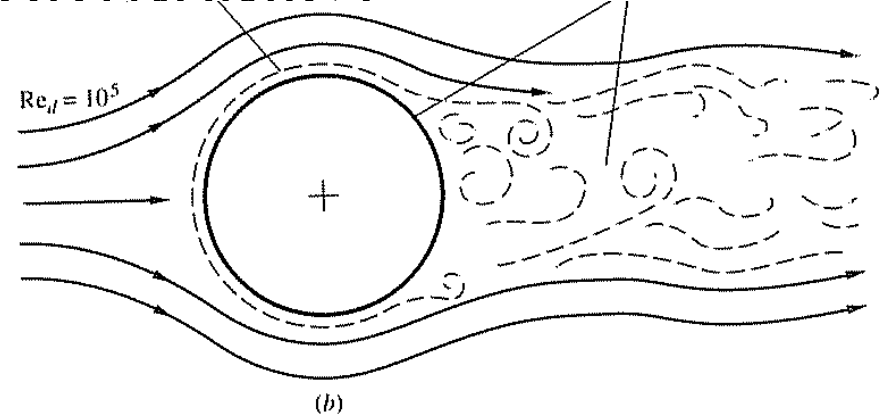
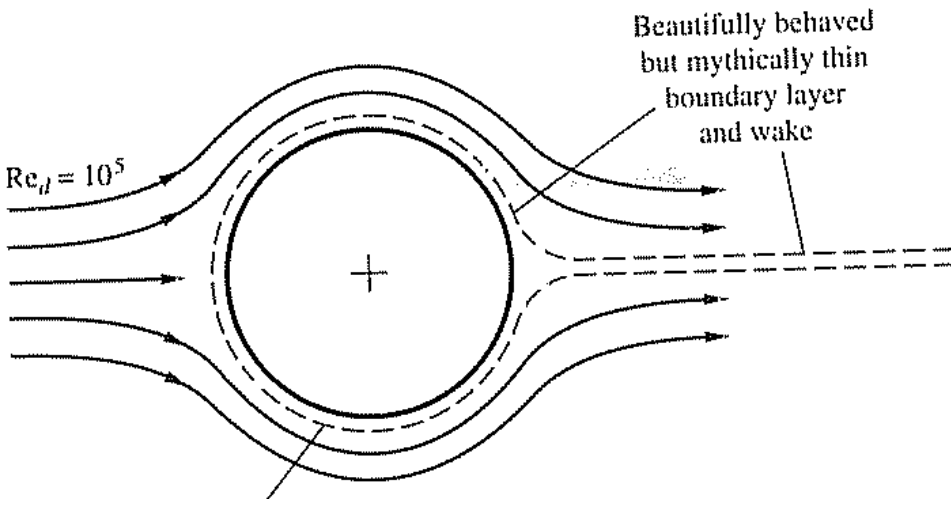

LAMINAR VERSUS TURBULENT FLOW

- Reynolds number also tells you about two types of viscous flows
 - Laminar: streamlines are smooth and regular and a fluid element moves smoothly along a streamline
 - Turbulent: streamlines break up and fluid elements move in a random, irregular, and chaotic fashion

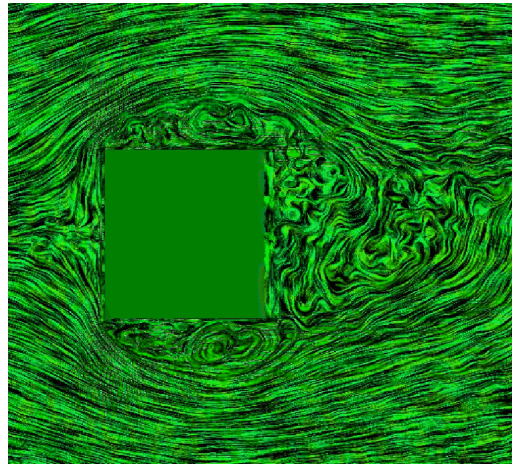
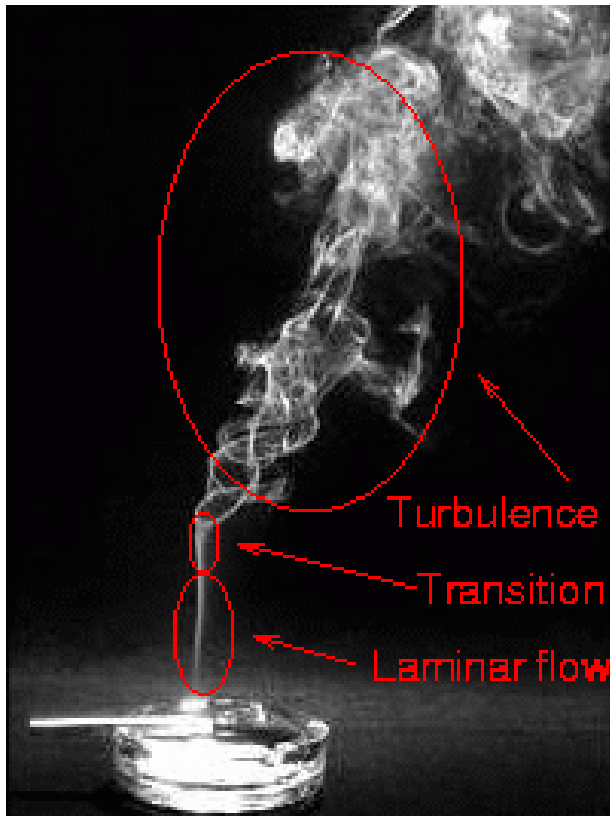

GOLF BALL AERODYNAMICS

**Large Wake of Separated
Flow, High Pressure Drag
Laminar B.L. Separation Point**

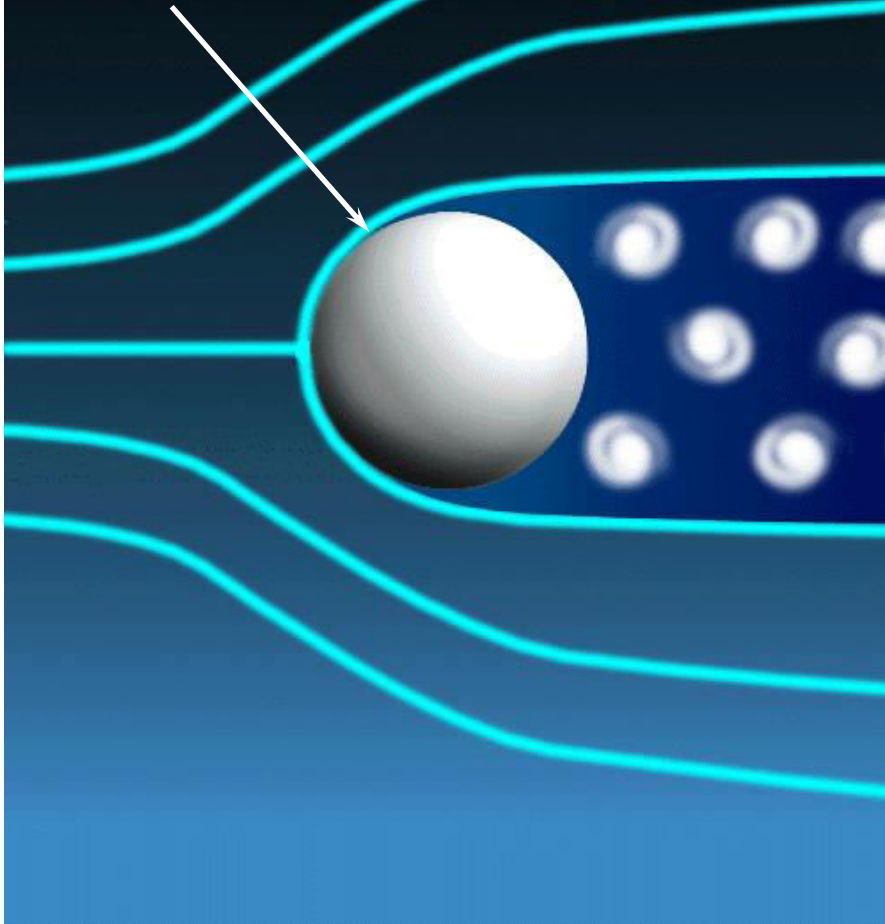

**Reduced Size Wake of Separated
Flow, Lower Pressure Drag
Turbulent B.L. Separation Point**

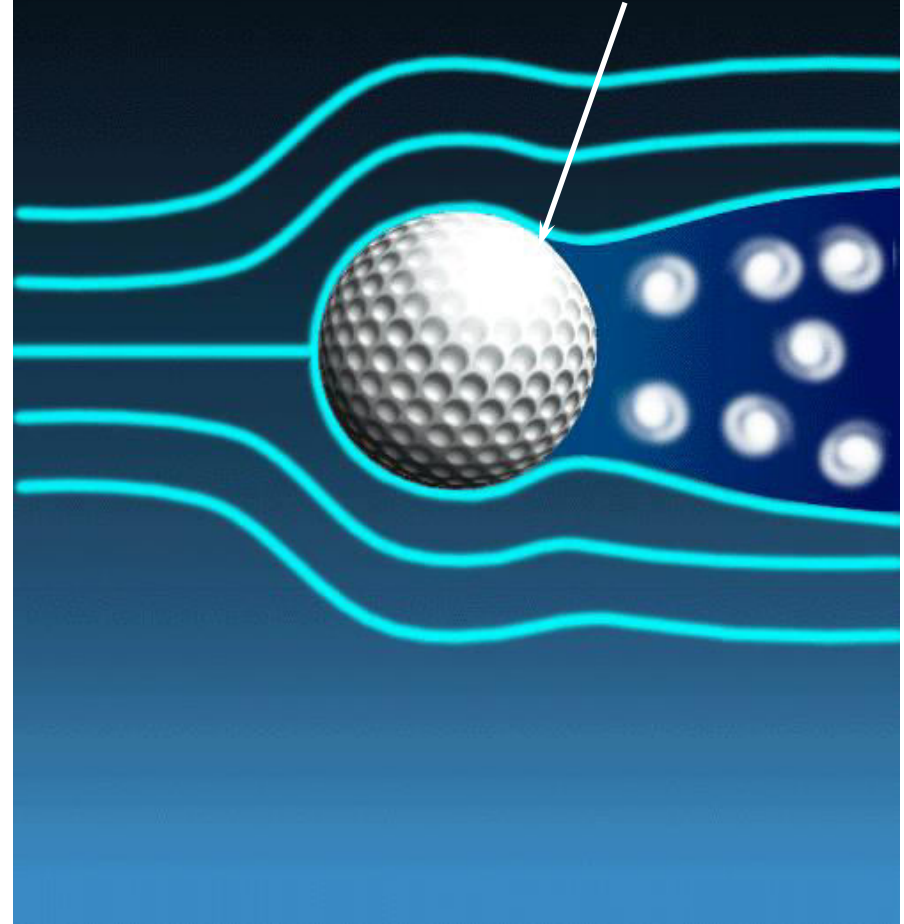

Contents :

- Propulsion
- Aircraft engine
- Types of Aircraft engine
- Aero piston engine
- Gas turbine engine
- Brayton cycle
- Other engines
- Electronic Fuel Injection

- Propulsion is an energy which creates force from the engine to make the aircraft move forward.
- On airplanes, thrust is usually generated through some application of Newton's third law of action and reaction. A gas, or working fluid, is accelerated by the engine, and the reaction to this acceleration produces a force on the engine.

- An aircraft engine is the propulsion unit(power plant) which generates thrust and pushes the aircraft to move forward direction to reach higher level.
- Most of the aircraft engines are either run by the piston engine and gas turbines.
- The aircrafts which are powered by piston engines comes under (Light civil aviation).

Reciprocating engine or IC engine

- Most of the piston engines consists of reciprocating engines.
- It consists of cylinders , piston , sparkplug ,crank case , connecting rod , valves.
- Reciprocating engines operate on a four-stroke cycle, where each piston travels from one end of its stroke to the other four times

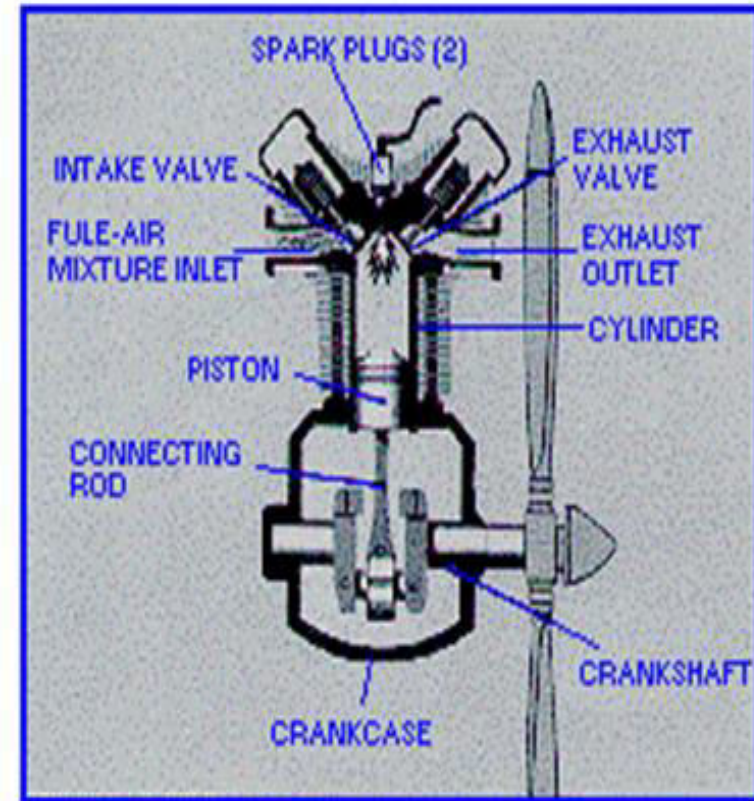

Figure 6-2 Parts of the reciprocating engine

- The cycle is composed of four operations:
 - Intake,
 - Compression,
 - Expansion (or power),
 - Exhaust.
- With ignition taking place late in the compression stroke and combustion of the fuel-air charge occurring early in the expansion.
- The reciprocating engines work on the Otto power cycle.

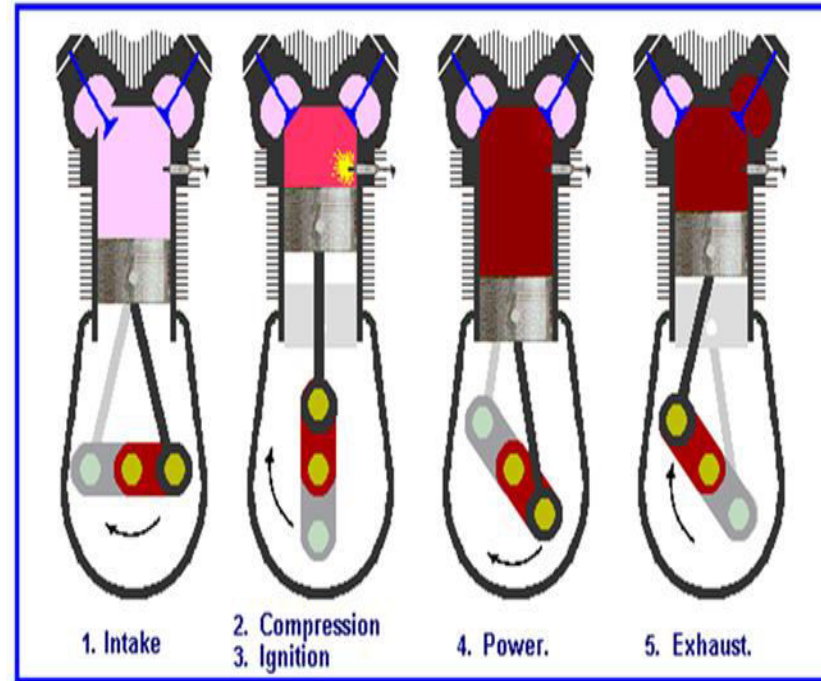
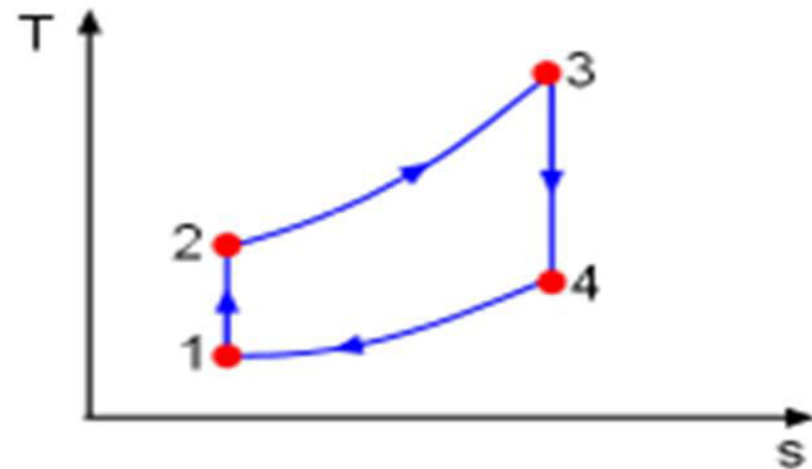
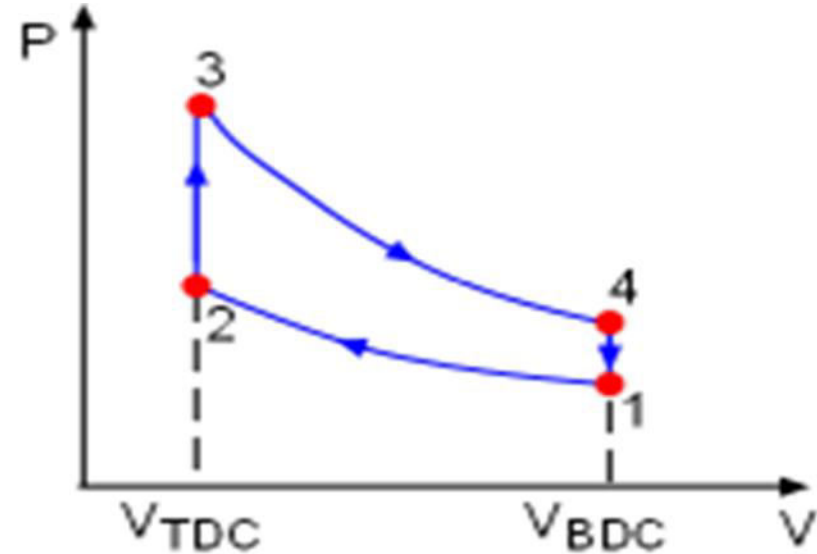

Figure 6-3 Four-stroke five-event cycle.

Otto Cycle:

- Process 1-2 is an adiabatic compression.
- Process 2-3 is a heat addition at constant volume (isochoric).
- Process 3-4 is an adiabatic expansion.
- Process 4-1 is a heat rejection at constant volume.



Types of reciprocating engines

- In 1903 after the wright brothers first successful flight ,the making aircraft engine has been started.
- Basically there are three types of reciprocating engines.

- In 1918 in world war I where aircrafts were first being used for military purposes.
- It is an early type of IC engine.
- It is designed with no. of cylinders per row, crankshaft remains stationary, entire cylinder block rotates around it the entire engine rotates with the propeller which drives plenty of air inside for cooling purpose.
- It can generate up to 80 HP and gave good power to weight ratio .
- Major disadvantage was it became difficult to fly as it consumed large amount of castor oil .

V shaped

- The cylinders were aligned in two separate planes from each other tilted at an angle of 30-60 degree, where the crank shaft holds the both pistons .
- Rolls Royce was first to design the V shaped engines for aircraft .
- V shaped designs gives high power to weight ratio and high reciprocating torque or mass .
- The famous V12 engine played a major role in world war II.

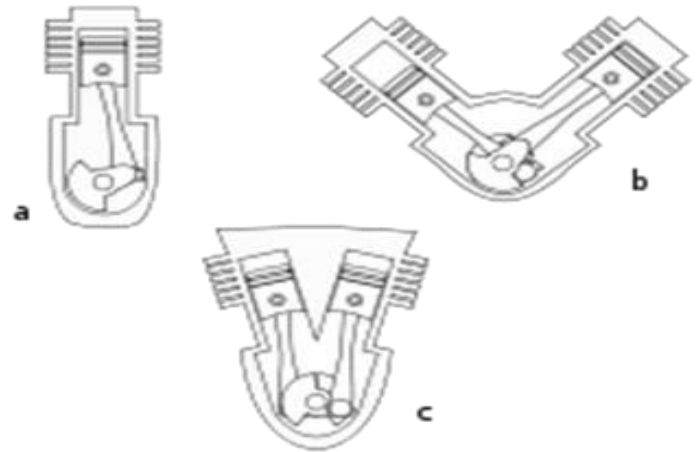

Gas Turbine engines

- After world war II designers dreamed to invent an engine which can break the sound barrier (speed of sound), which led to the discovery of gas turbine engines which was called as Jet engine.
- Gas turbine engines work on **Brayton power cycle**.

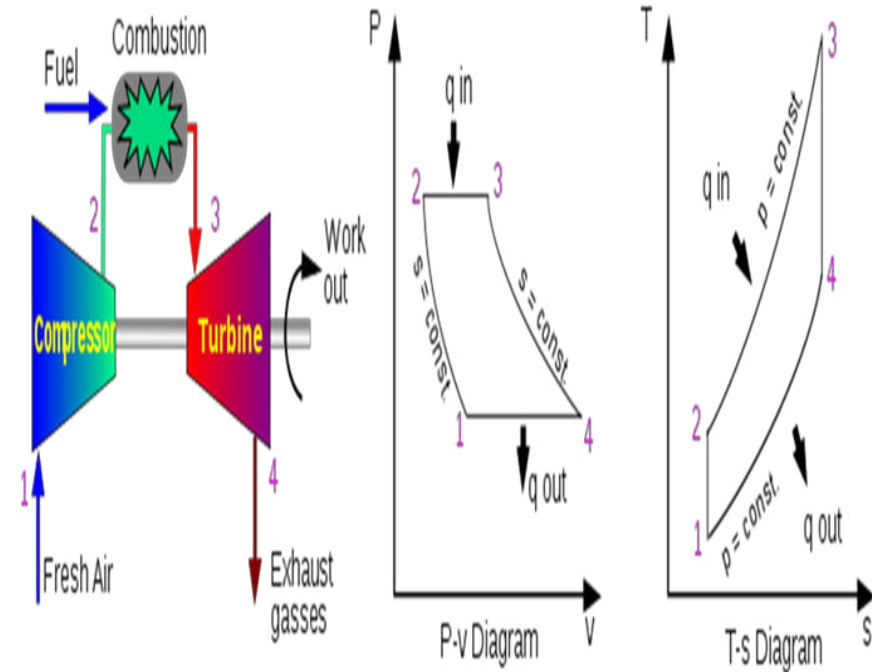

- The air enters the compressor gets compressed and the compressed air enters in to the combustion chamber, where the fuel and air are mixed and burnt and passes through the turbine, exit through nozzle with high acceleration.

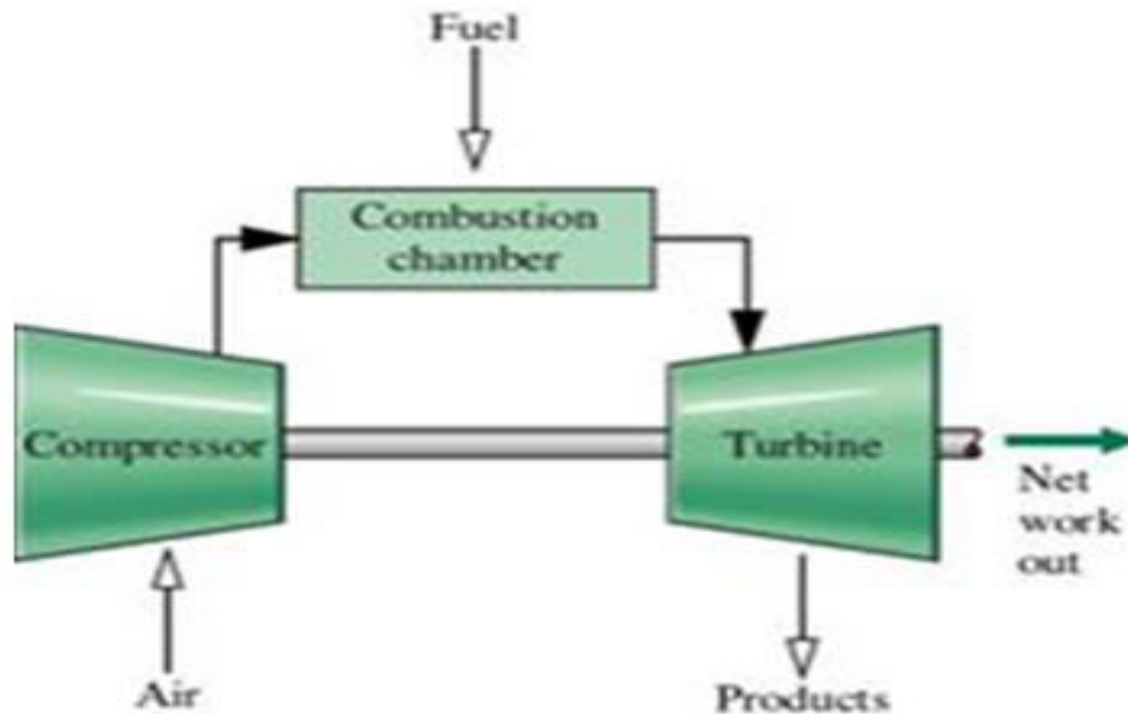

Brayton Cycle

- Since fresh air enters the compressor at the beginning and exhaust are thrown out at the end, this cycle is an open cycle.
- By replacing the combustion process by a constant pressure heat addition process, and replacing the exhaust discharging process by a constant pressure heat rejection process, the open cycle described above can be modified as a closed cycle, called ideal Brayton cycle. The ideal Brayton cycle is made up of four internally reversible processes.

- 1-2 Isentropic compression (in a compressor)
- 2-3 Constant pressure heat addition
- 3-4 Isentropic expansion (in a turbine)
- 4-1 Constant pressure heat rejection

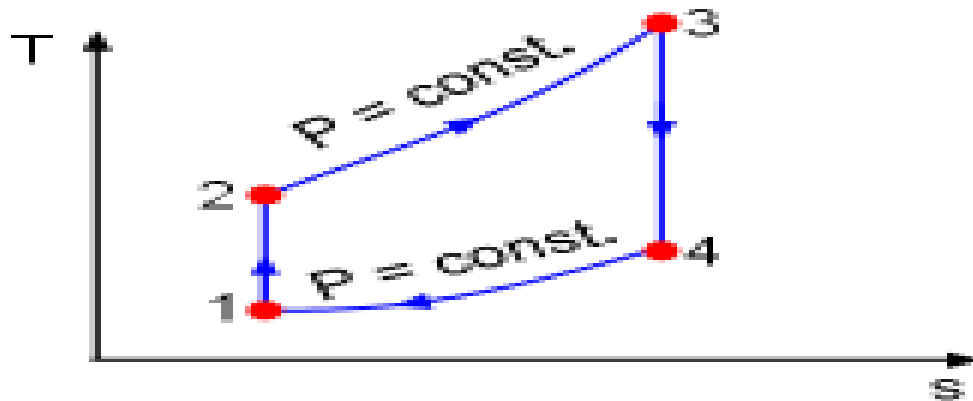
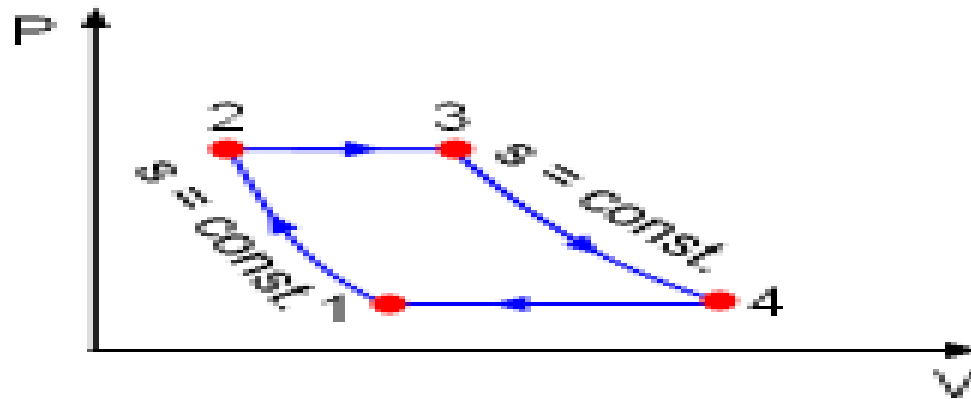

- Aircraft propellers convert rotary motion from piston engines or turboprops to provide propulsive force.
- The propellers are provided with several rows of spinning blades called Rotors.
- As the airflow goes through each row, the air is accelerated and compressed.
- The air after passing through the several rows of rotors gets compressed. This stage of the engine is called the Compressor.
- The compressed gas enters a Combustion Chamber where fuel is added and a spark ignites the fuel/air mixture and this flame is self-sustaining.

- The high pressure, high temperature gases exit from the combustion chamber and expand in the turbine to generate enough power .
- The exhaust gases leave the turbine.

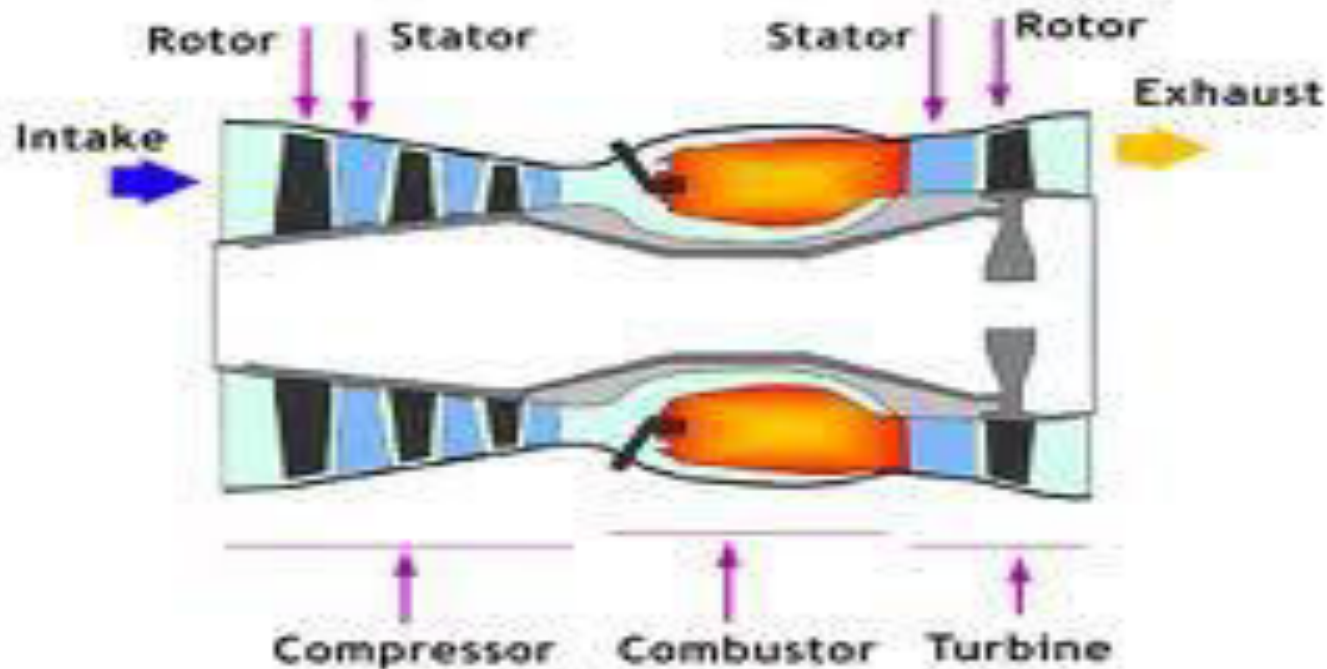

Types

- **1.Turbo jet** - The turbojet uses a series of fan-like compressor blades to bring air into the engine and compress it.
- It works with working fluid(air) consists of inlet compressor , combustion chamber , turbine , nozzle.
- Turbo jet gives good efficiency at higher speeds (800km/h) and high rate of climb and un interrupted power supply.

Turbojet Thrust

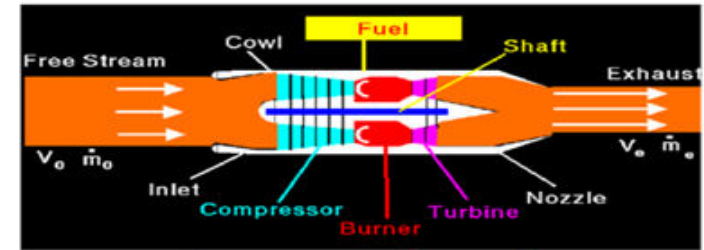

$$\text{Thrust} = F = \dot{m}_e V_e - \dot{m}_0 V_0$$

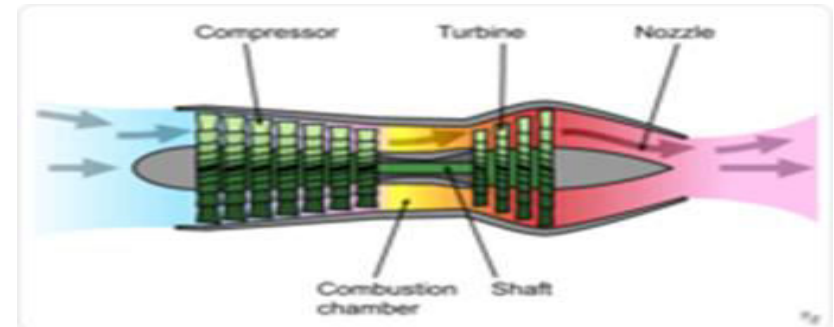

- **2.Turbo prop-** It is a combination of propeller engine and turbo jet engine.
- It consists of a propeller and reduction gear box in the front to reduce the speed of rpm.
- Works same as turbo jet it used by mostly military and also civil aviation.

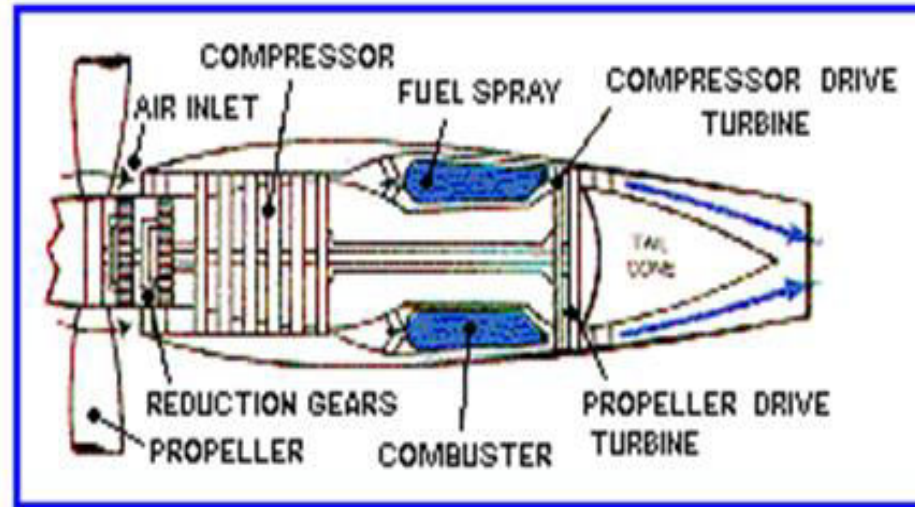
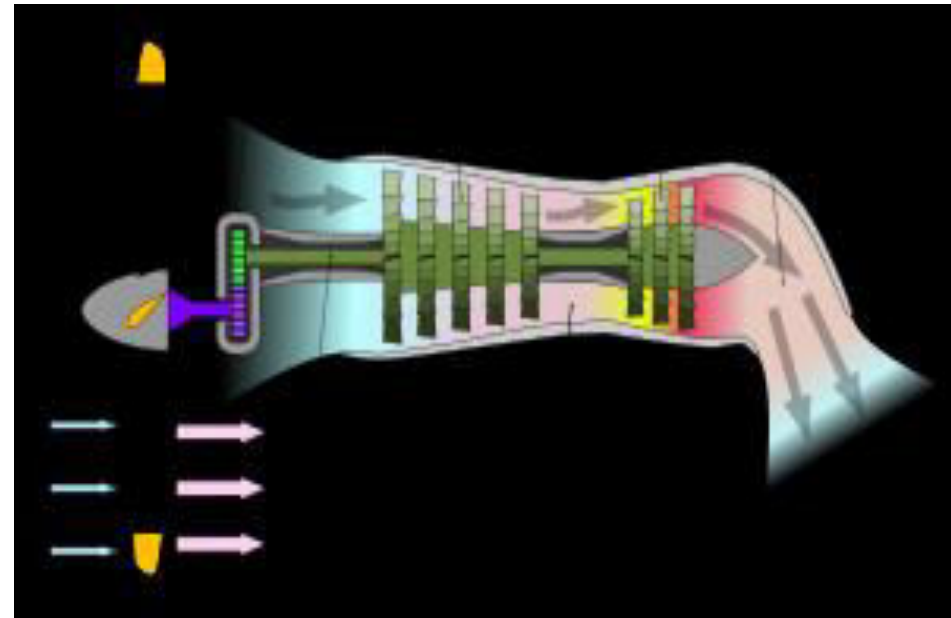

Figure 6-9 Axial-flow turboprop engine.



- **3.Turbo fan** - It has one or more rows of compressor blades extend beyond the normal compressor blades. The result is that four times as much air is pulled into the turbofan engine as in the simple turbojet.

- Most of this excess air is ducted through by passing around the power section and out the rear with the exhaust gases.

- The turbofan has greater thrust for takeoff, climbing, and cruising on the same amount of fuel than the conventional turbojet engine.

- It has the facility of thrust augmentation like (afterburner, bleed burner) turbofan engine has gained lot more popularity then turbo jet.

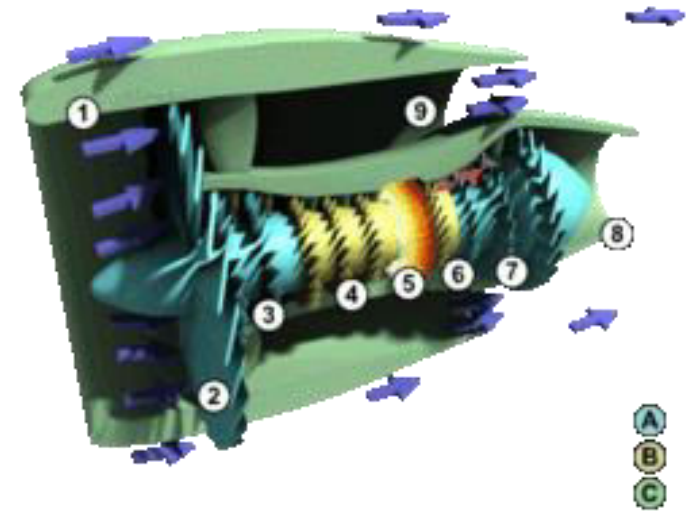
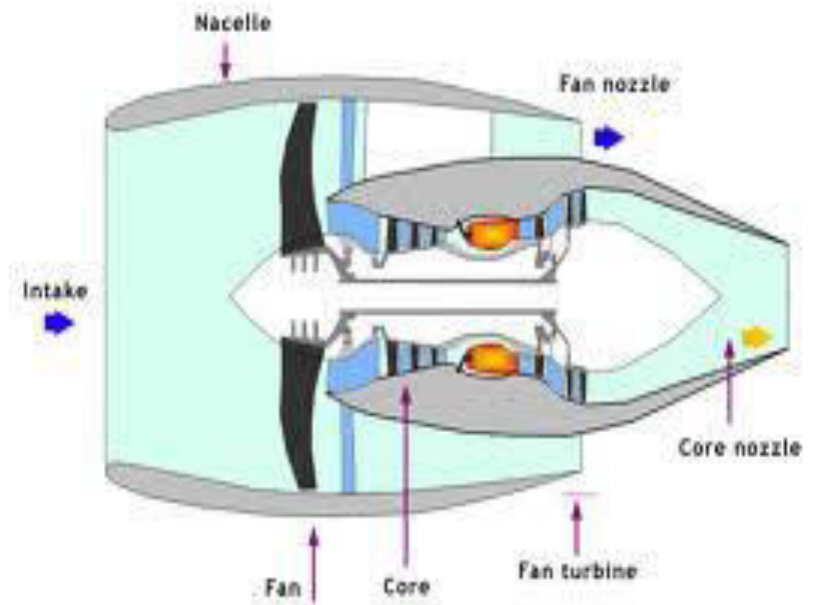

- **4. Ram jet** - After the achievement of turbine engines ,designers, engineers dreamed of building the engine which could travel at high speeds and reach at any point on earth in less time. These led to the development of ramjet, scramjet engines.
- The ramjet engine is the simplest type of the all-jet engines because it has no moving parts.
- And works by supersonic air flow at inlet.
- The sharp edge acts as a diffuser and the flow get further compressed inside and reach the combustion chamber where the fuel and air is mixed and ignited and exits through converging nozzle.
- It can work only at supersonic speeds not suitable for less then (Mach no.1).

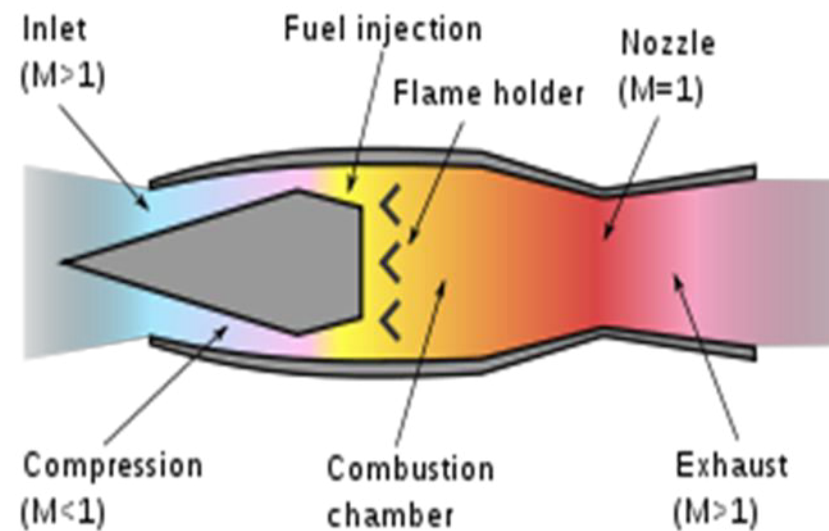

- **5.Scramjet** – Super sonic combustion ramjet engine works on oblique shock waves.
- The shock waves pass through inlet and get compressed through deflections occurred inside the walls and ignited with fuel and exit through nozzle.
- It can travel more than Mach no. 10, suitable for hyper sonic speeds.
- Mostly used in space launch vehicles , supersonic missiles.

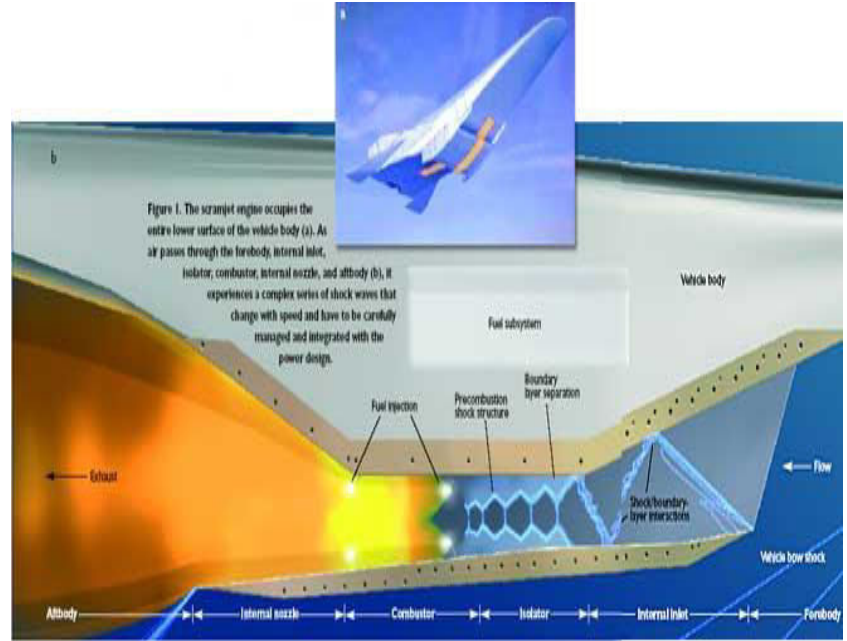
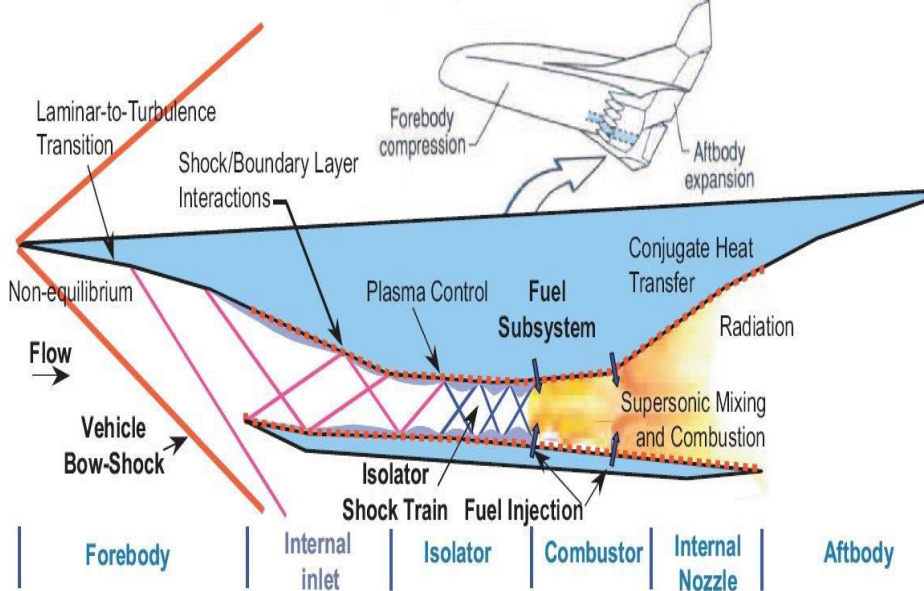

- What is rocket –Rocket is a vehicle is used to launch astronauts(crew) or payload in to space.
- It works on Newton’s third law by obtaining thrust from its rocket engine and throwing the exhaust jet backwards through a supersonic nozzle which pushes the rocket forward.

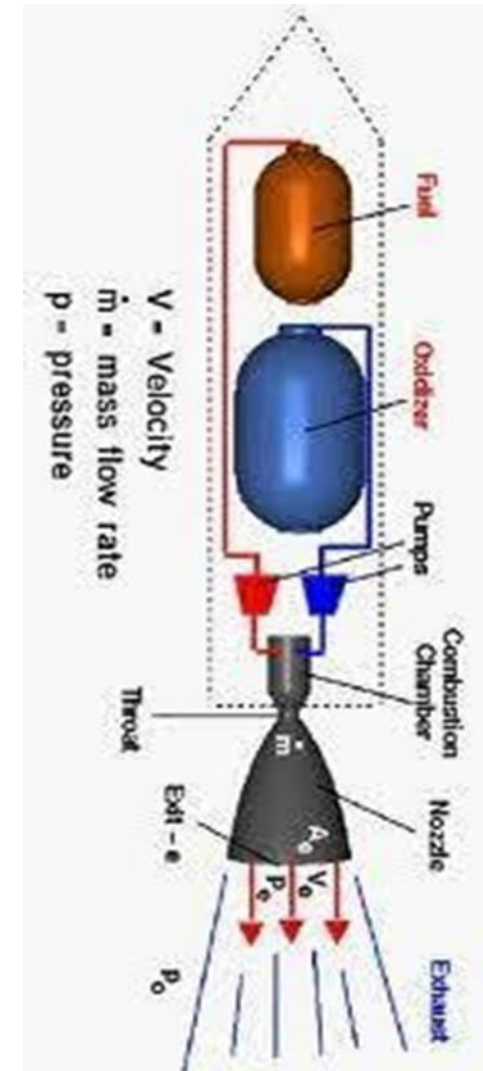

- It is a non air breathing engine in which the propellant acts as fuel and the combustion takes place internally and the exhaust acts as working fluid
- Propellant is a mixture of chemicals which produces high pressurized gas for thrust, which accelerates the rocket
- There are two main types of rockets
- 1) Solid propellant rockets- we use solid propellants in which the propellants are mixed together and stored in a cylinder, under normal temperature and ignited with the igniter, once the burning starts it proceeds until the propellant lasts
- A solid propellant is much easier to handle and can sit for years before firing
- Propellants are loaded into the rocket just before launch
- Solid propellants are mostly used in missiles and side boosters for space shuttles

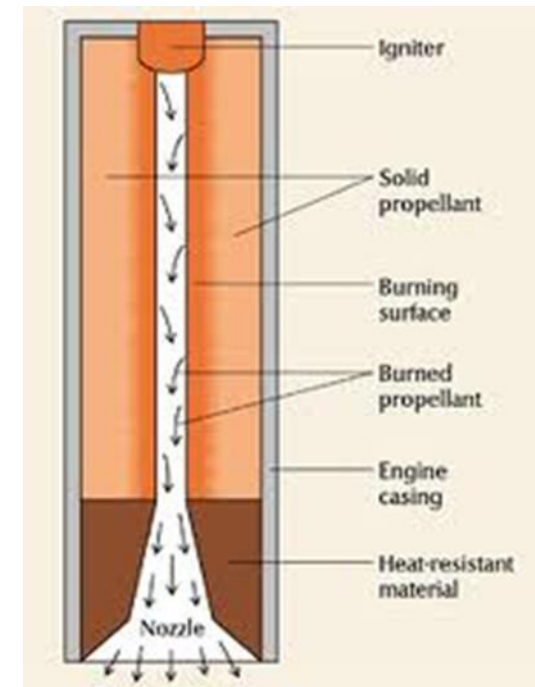

- *Liquid rocket-consists of liquid propellants (oxidizer, fuel) stored in liquid form in tanks separately and pumped in to combustion chamber where both oxidizer, fuel is mixed and ignited which produces high exhaust gas and exited through nozzle*
- *With liquid rockets u can stop the thrust by turning of the flow of propellants and can restarted again. Space shuttle and human space craft use liquid propellants*
- *Propellants can be in the form of mono propellants,bi propopellentsand hybrid(solid,liquid) propellants*
- *Presently most of the rockets are using hybrid propellants .*

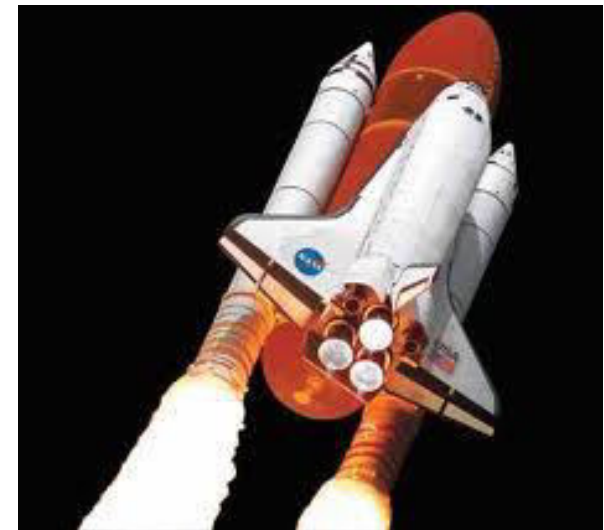
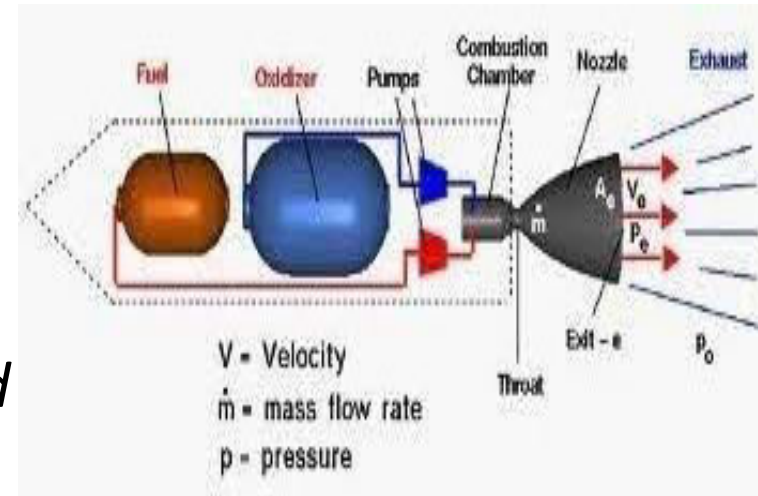

THRUST VECTOR CONTROL

- **Thrust vector control is a method of manipulating the direction of thrust from its engine in order to control the altitude and angular velocity of an aircraft or rocket**
- **It plays major important role for (VTOL),(STOL) aircrafts and also used in combat situation which enables to perform various maneuvers in military aircraft**
- **technique of thrust vectoring was envisaged to provide upward vertical thrust as a means to give aircraft Vertical Take-Off and Landing or Short Take-Off and Landing ability. Later it was realized that using vectored thrust in combat situations could enable aircraft to perform various maneuvers**
- **Most aircraft currently equipped with thrust vectoring ability use turbofans with rotating nozzles or vanes in order to deflect the exhaust stream.**

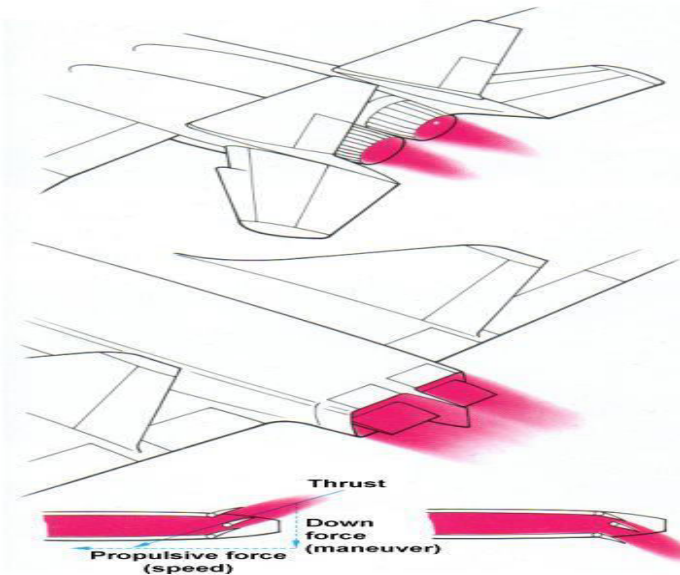
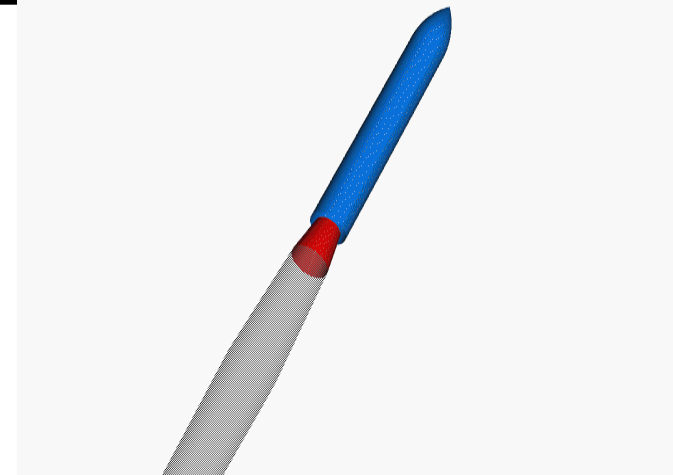

THRUST VECTOR NOZZLE

- Thrust vectoring is done through movable nozzles called vectoring nozzle
- These are specialized nozzles that facilitate the upward or downward movement of thrust vectoring so an aircraft can fly forward or hover over the ground.
- By altering the angle of these nozzles, the ratio of longitudinal thrust to lift thrust could be varied, such that with the nozzles directed towards the ground, the aircraft could hover, stationary to the ground, and could even move backwards.
- There are many types of vectoring nozzles like vectoring flaps ,Rotating flaps, elbow joint

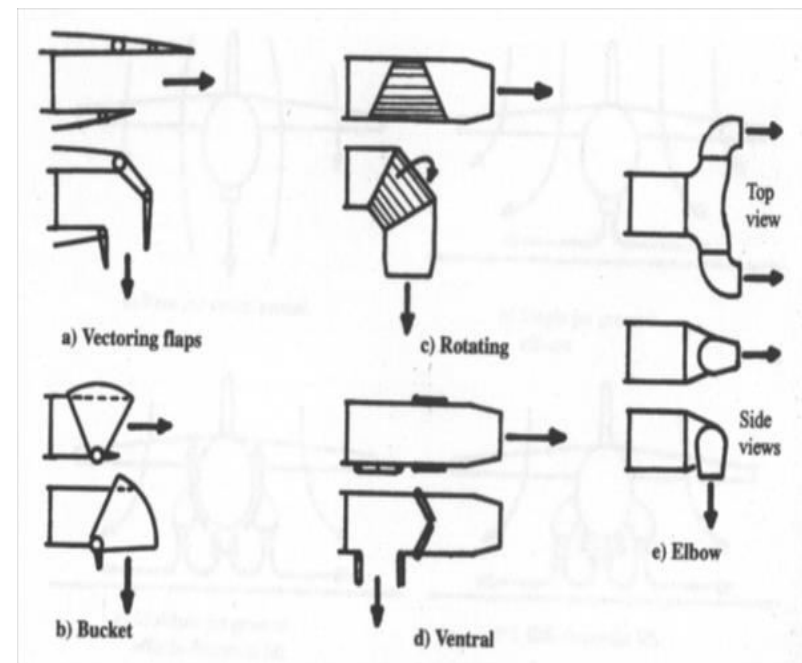
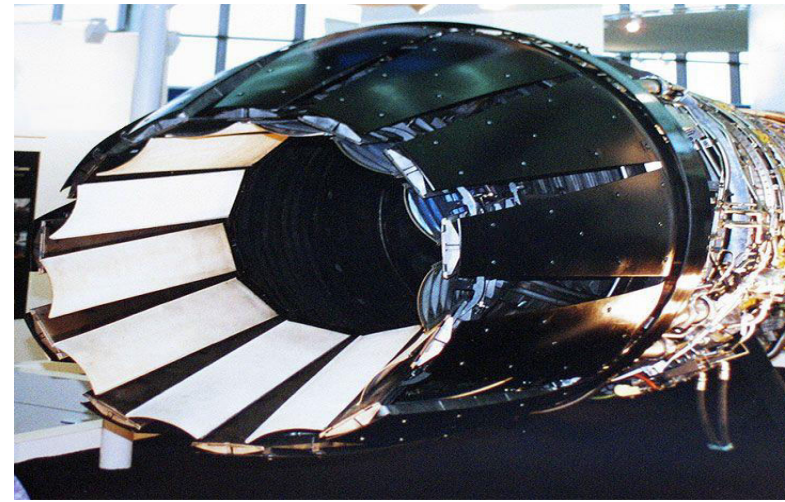

ADVANTAGES OF THRUSTVECTOR CONTROL(TVC)

1)Short take off and Landing (STOL)

Aircraft that have small take off and landing zones are largely advantageous as it reduces the space required for operation of the aircraft. This allows the aircraft to operate in more compact environments such as aircraft carriers and airports

2)Fuel Consumption, Flight Range

an aircraft with TVC requires less thrust to achieve desired results such flight regimes as cruise, climb and decent. This has the effect it reduces the fuel consumption of the aircraft due to the lower thrust requirement, which in turn increases the aircrafts flight range.

Project engines

- **Sinus** is a ultra light motor glider.
- Built by Pipistrel company .
- Consists of Rotax 912 model engine.
- Detailed specifications :-
 - Cruise speed 200km/h
 - Range 1,200km/h
 - Rate of climb-6.2 m/s
 - Service ceiling -8,800m



- It has horizontally opposed four cylinder ,four stroke cylinder with gear reduction.
- Produces 80hp and has capacity of 1,211cc and compression ratio of 9.1 : 1.
- Equipped with dual carburettor and electronic fuel injection .

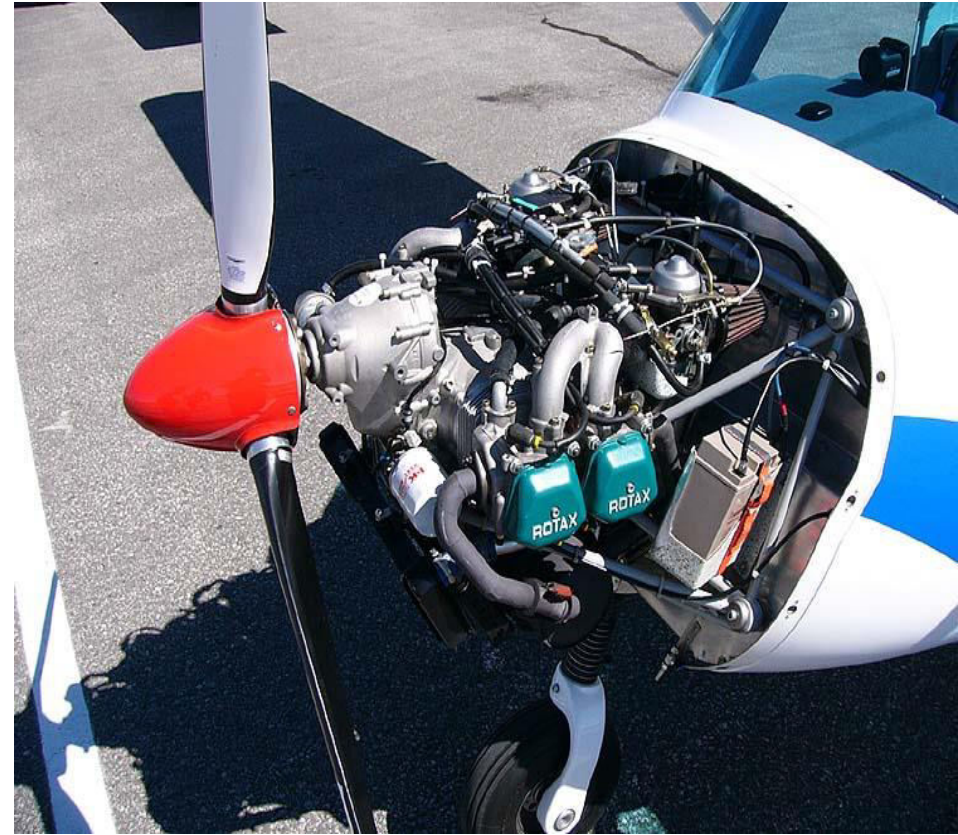

Carburettor

- Carburettor is a device that blends air and fuel for an IC engine , which works on Bernoulli's principle.
- It basically consists of an open pipe which is in the form of venturi and a butterfly valve called throttle valve.
- The air enters into inlet manifold of the engine.
- The throttle valve controls the flow of air and quantity of air fuel mixture through the carburettor throat by regulating engine power and speed.

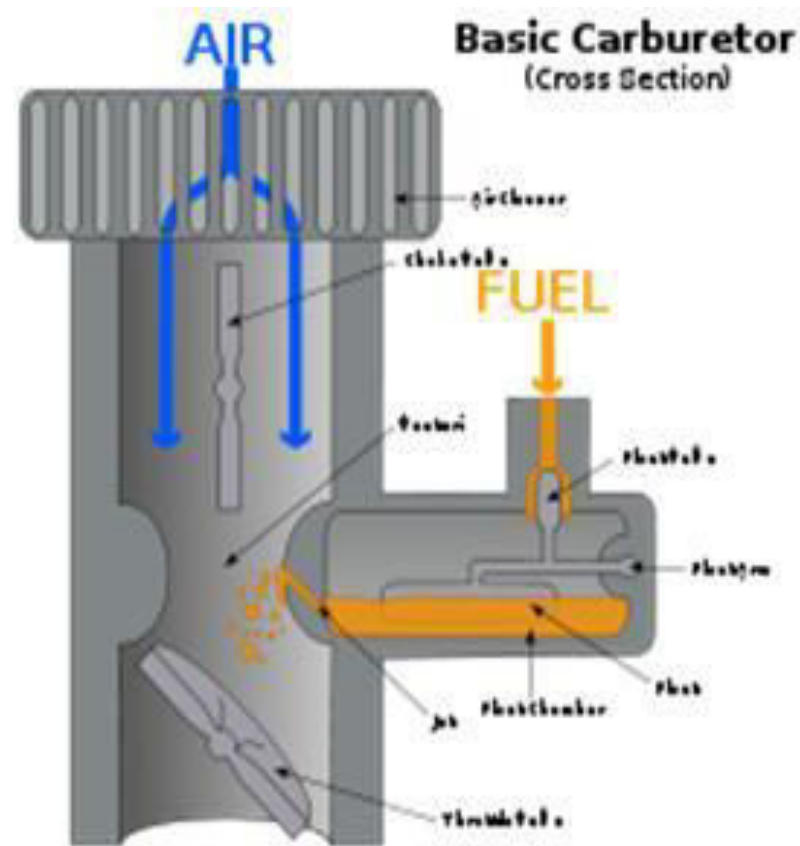

Electronic Fuel Injection

- Fuel injection is a system for admitting fuel into an internal combustion engine.
- EFI consists of three basic systems:
 - Electronic Control Unit(ECU)-which determines basic injection quantity.
 - Fuel delivery system maintains a constant fuel pressure on the injector.
 - The air induction system delivers air to the engine based on demand.

UNIT-3

Aircraft Motion and Control

Objective: Know basic aircraft motion and how it is controlled.

1. Identify the axes of rotation.
2. Identify the effects of ailerons and elevators on flight.
3. Identify the effects of flaps on flight.
4. Identify the effects of the rudder on flight
5. Identify the effects of spoilers on flight.

Bernoulli Principle

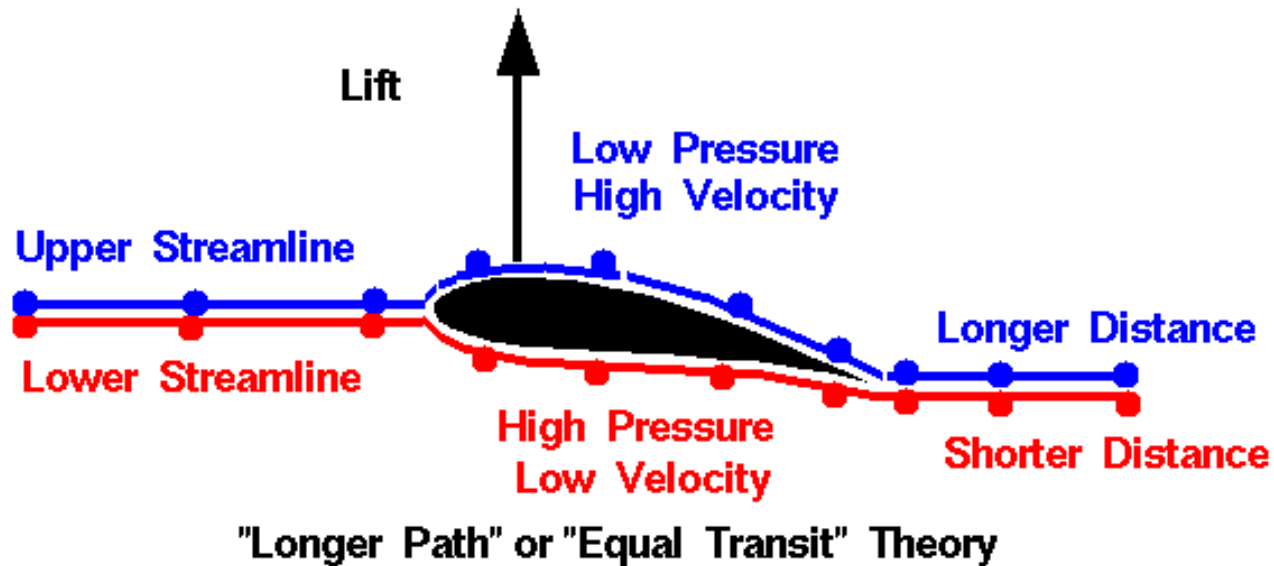

- As the air velocity increases, the pressure decreases; and as the velocity decreases, the pressure increases

The Axes of Rotation

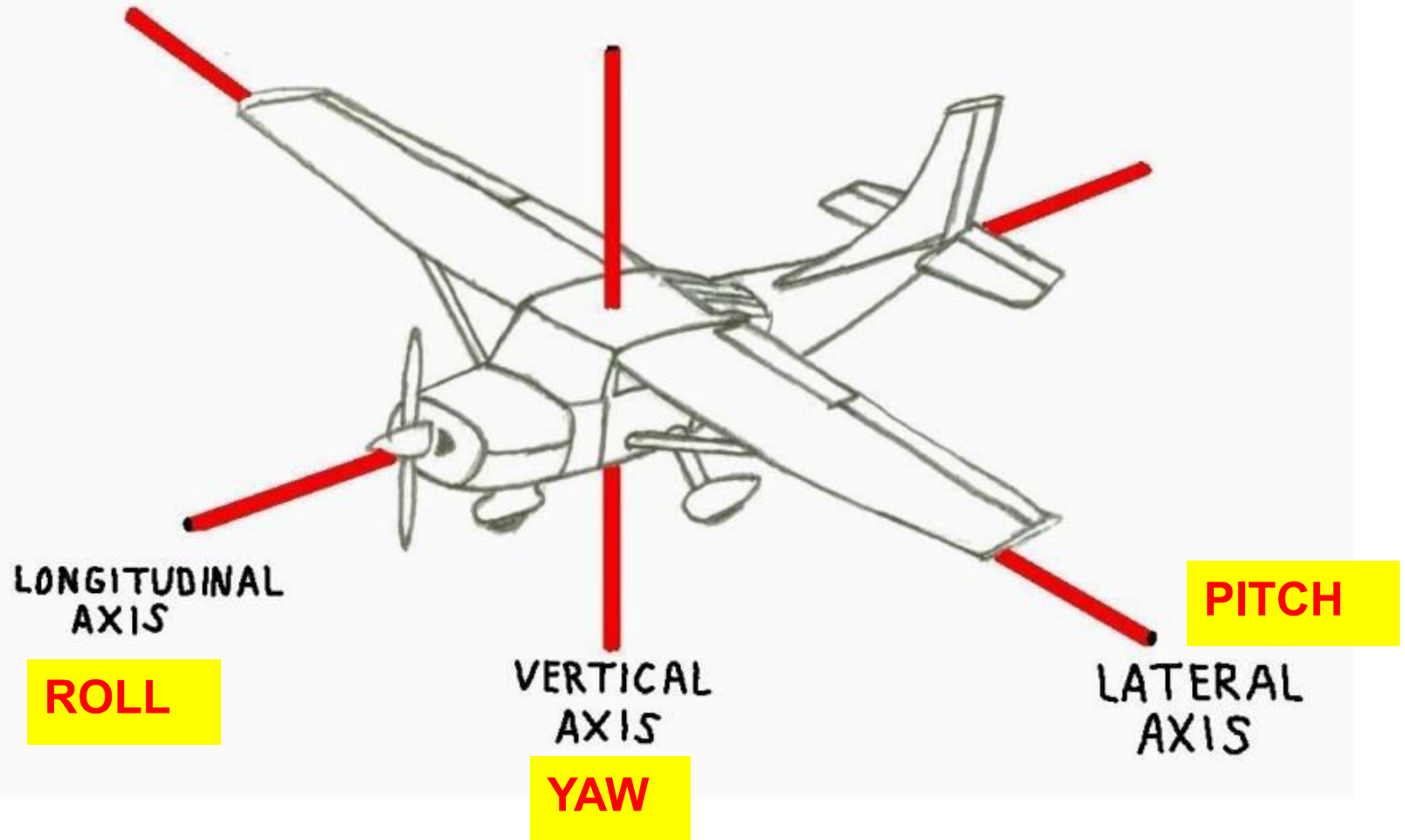

The Axes of Rotation

- Longitudinal Axis
 - Running from the tip of the nose to the tip of the tail. This axis can be thought of as a skewer which turns either right or left and causes everything attached to it to turn.

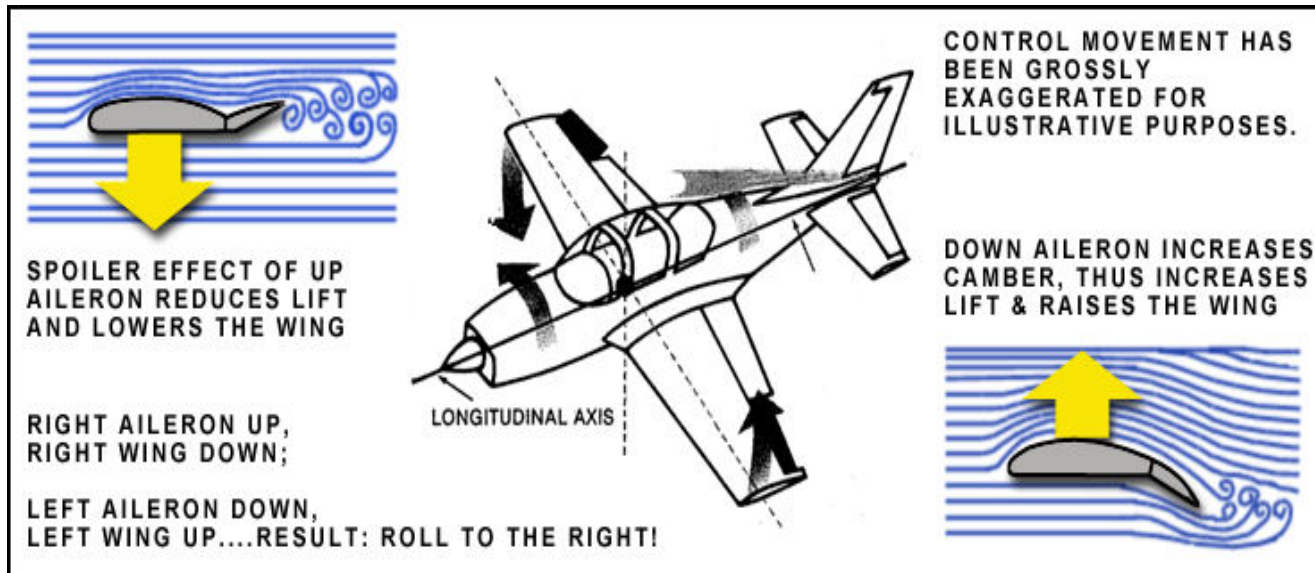

The Axes of Rotation

- Longitudinal Axis
 - The cause of movement or roll about this axis (**roll** axis) is the action of the **ailerons**.

The Axes of Rotation

- Lateral Axis
 - An imaginary rod, running from one wing tip through the other wing tip, forms an airplane's lateral axis.
 - Another name for the lateral axis is the **pitch** axis.
 - The **flaps and elevators** can be deflected up or down as the pilot moves the control column backward or forward.

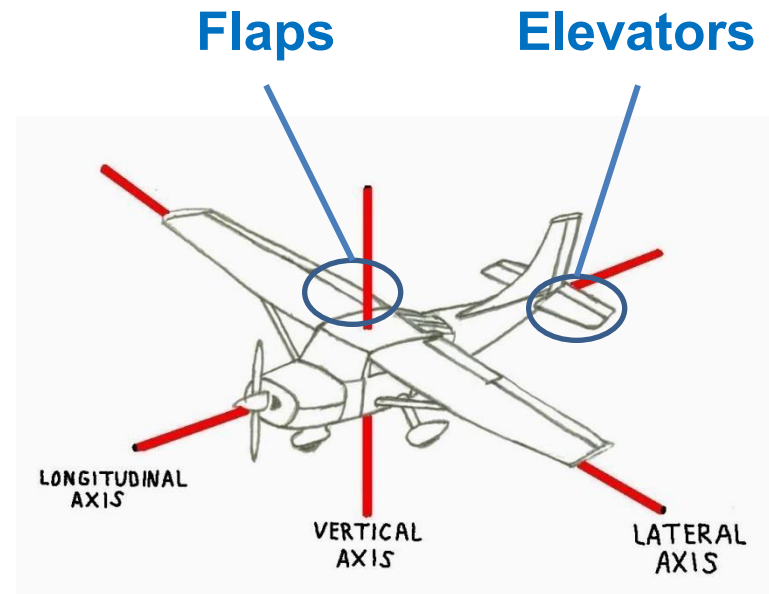

Flaps

- The flaps are attached to the trailing edge of the wing. In cruising flight, the flaps simply continue the streamline shape of the wing's airfoil.

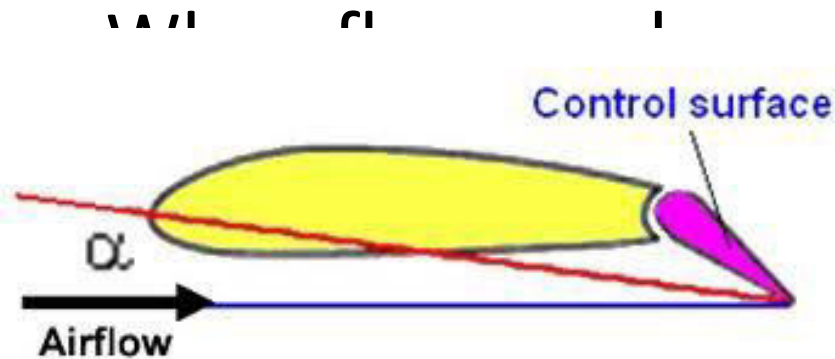

ed either partially or
in

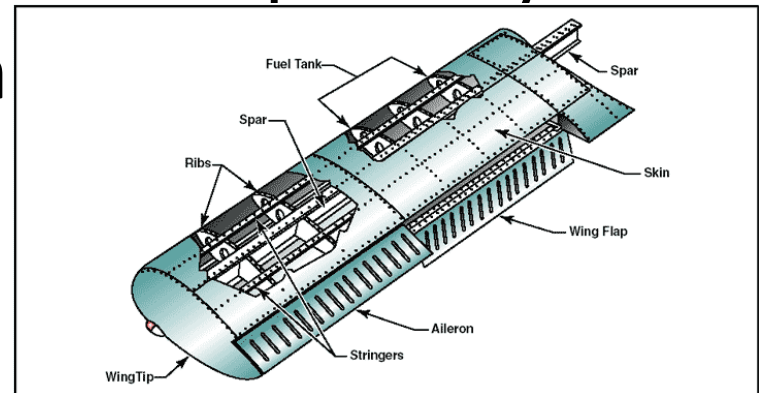

Flaps

- Flaps increase the camber of the wing airfoil for the portion of the wing that it is attached.
- This causes the air to speed up over the wing section where the most lift is created.
- On the underside of the wing, dynamic lift is increased.
- Using flaps we get off the ground more easily.

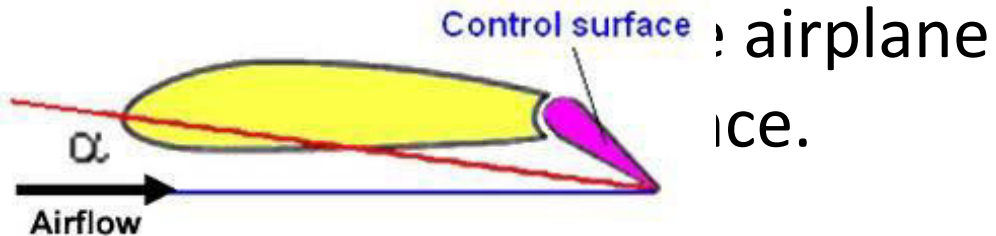

The Axes of Rotation

- Vertical Axis

- An imaginary rod or axis which passes through the meeting point of the longitudinal and lateral axes. It is also referred to as the “yaw” axis.
- The airplane turns about this axis in a side-to-side direction.
- The airplane’s **rudder** is responsible for the movement about this axis.

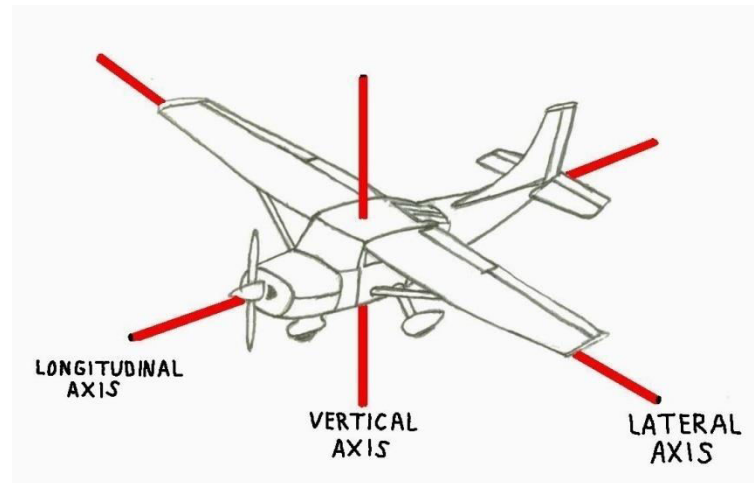

Rudder

- Located on the Vertical Stabilizer (tail)
- Controls the aircraft's yaw
- Right Rudder = Right Yaw
- Left Rudder = Left Yaw

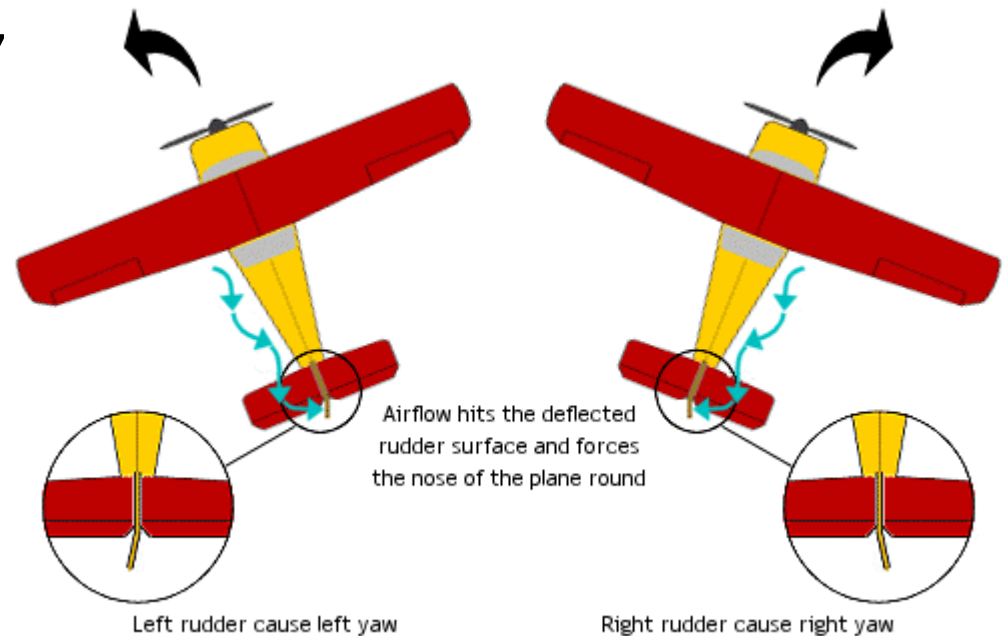

Spoilers

- Spoilers work to destroy lift.
- Spoilers are found on various aircraft from the jet airliner to the sailplane.
- On the jet airliners, spoilers are hinged so that their leading edges point upward into the smooth air stream.

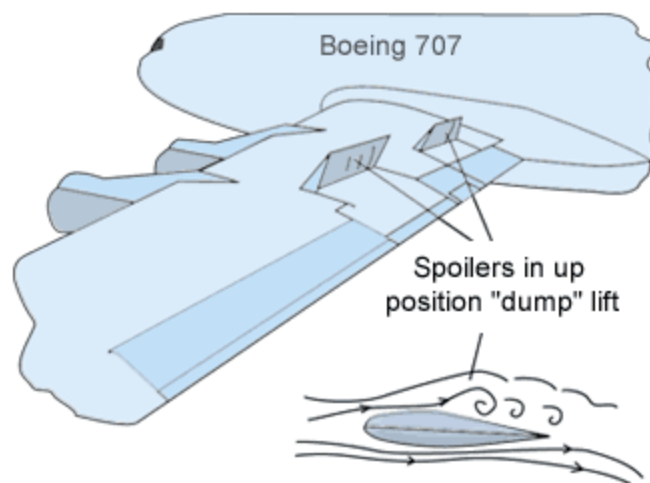

So Lets Put It all Together....

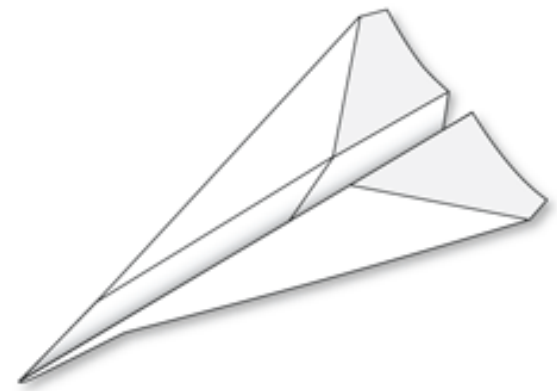
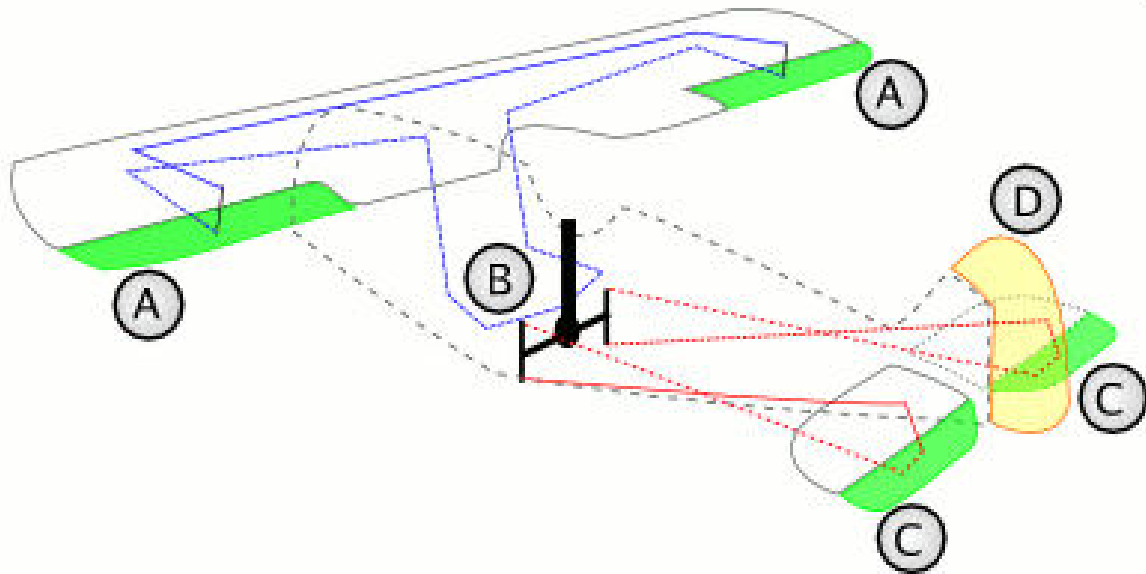



Review

- Which is **not** a primary axis associated with basic aircraft motion?

- A. Longitudinal Axis
- B. Lateral Axis
- C. Vertical Axis
- D. Diagonal Axis

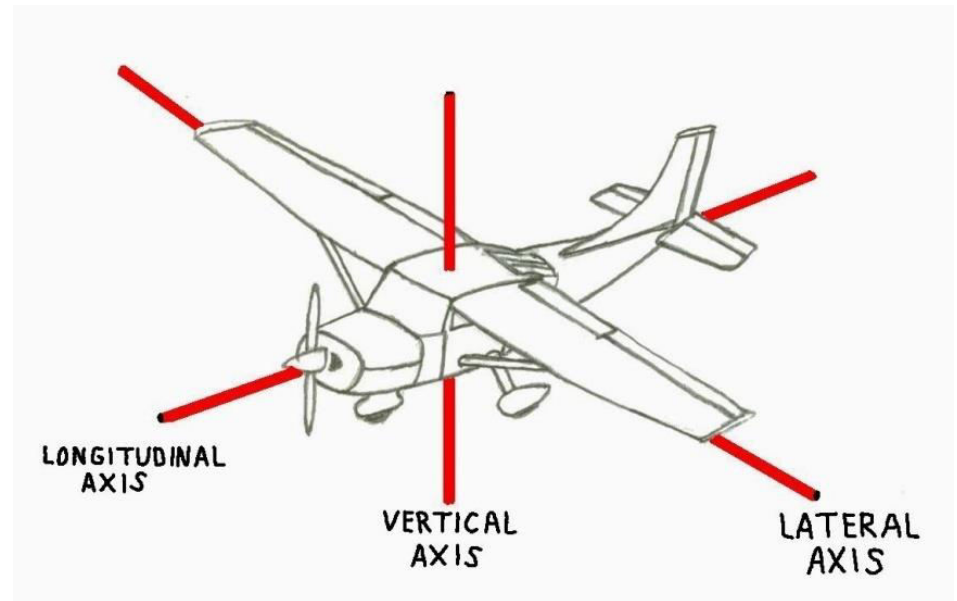

Review

- Affecting movement along the Longitudinal Axis, which basic aircraft control surface results in the aircraft **rolling**?

- A. Ailerons
- B. Flaps
- C. Elevators
- D. Rudder

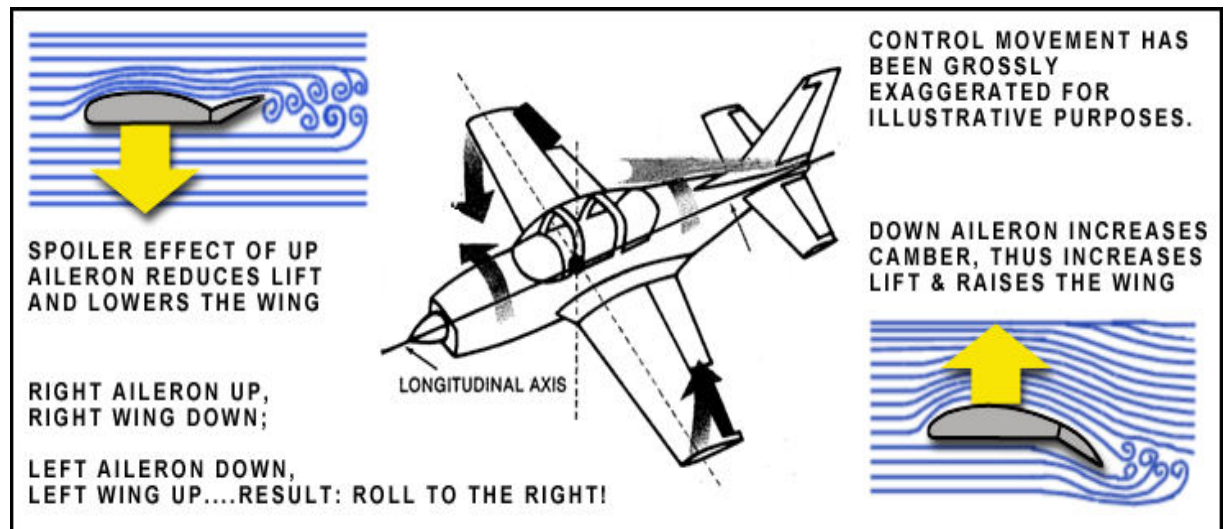

Review

- True or False? Extending flaps, increases both lift as well as drag?

A. True

B. False

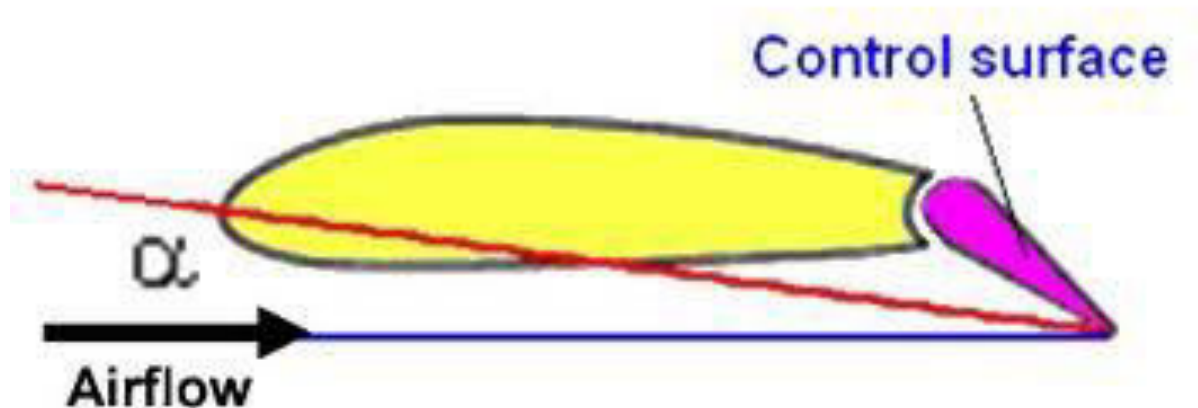

Review

- If an aircraft rudder was positioned as in the picture below, which direction would the aircraft begin to yaw?

A. Left

B. Right

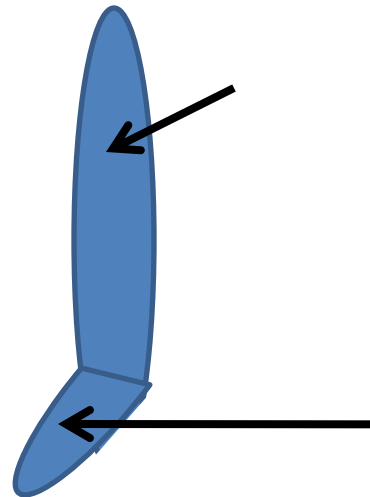

Aircraft Motion and Control

Objective: Know basic aircraft motion and how it is controlled.

1. Identify the axes of rotation.
2. Identify the effects of ailerons and elevators on flight.
3. Identify the effects of flaps on flight.
4. Identify the effects of the rudder on flight
5. Identify the effects of spoilers on flight.

Aerodynamics-Stability

- “The balance of an airplane in flight depends, therefore on the relative position of the center of gravity (CG) and the center of pressure (CP) of the airfoil” (PHAK 2-7).

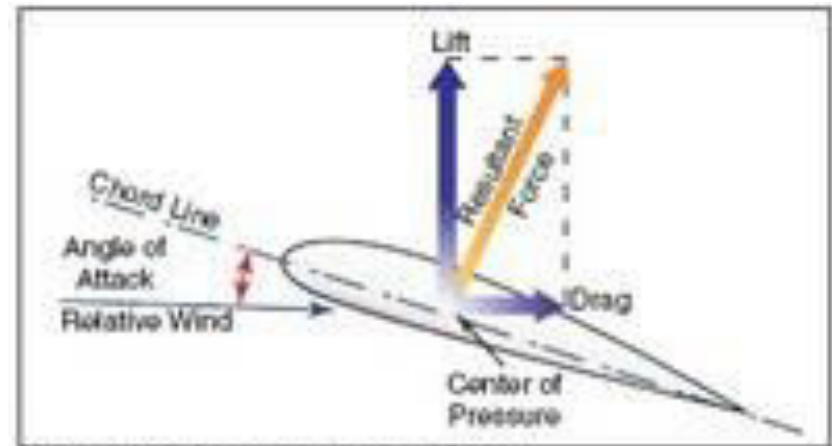

Figure 2-9. Force vectors on an airfoil.

Aerodynamics-Stability

- Therefore, if AOA increases, CP moves forward. If AOA decreases, CP moves aft.

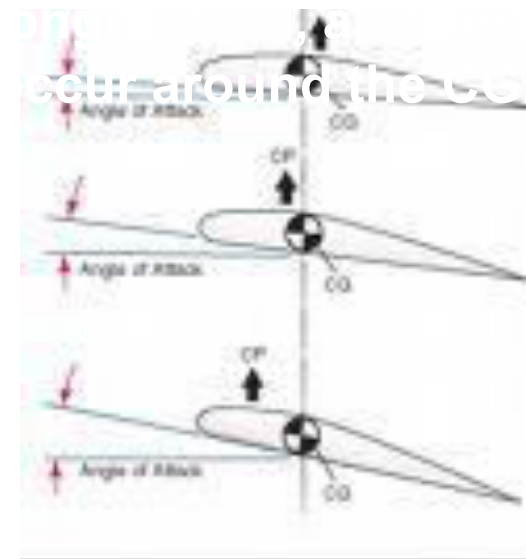

Figure 2-10: CP changes with an angle of attack.



Aerodynamics-Stability

- **Stability**=the tendency to correct back to the original state
- **Maneuverability**=the ability to change attitude and withstand stresses
- **Controllability**=the aircraft's response to pilot inputs

- Types of Stability: Static & Dynamic
 - Static- the aircraft's initial response
 - Dynamic-the response over a period of time

Aerodynamics-Stability

- Static Stability (initial tendency)
 - Positive Static=immediately return to the original state
 - Neutral Static=remain in the new position
 - Negative Static=continue away from the original state

Dynamic Stability (over time)

- Positive Dynamic=returns to original state
- Neutral Dynamic-Once displaced, the plane neither increases or decreases in amplitude, stays the same
- Negative Dynamic=continues going away, becomes more divergent if displaced

Aerodynamics-Stability

- St

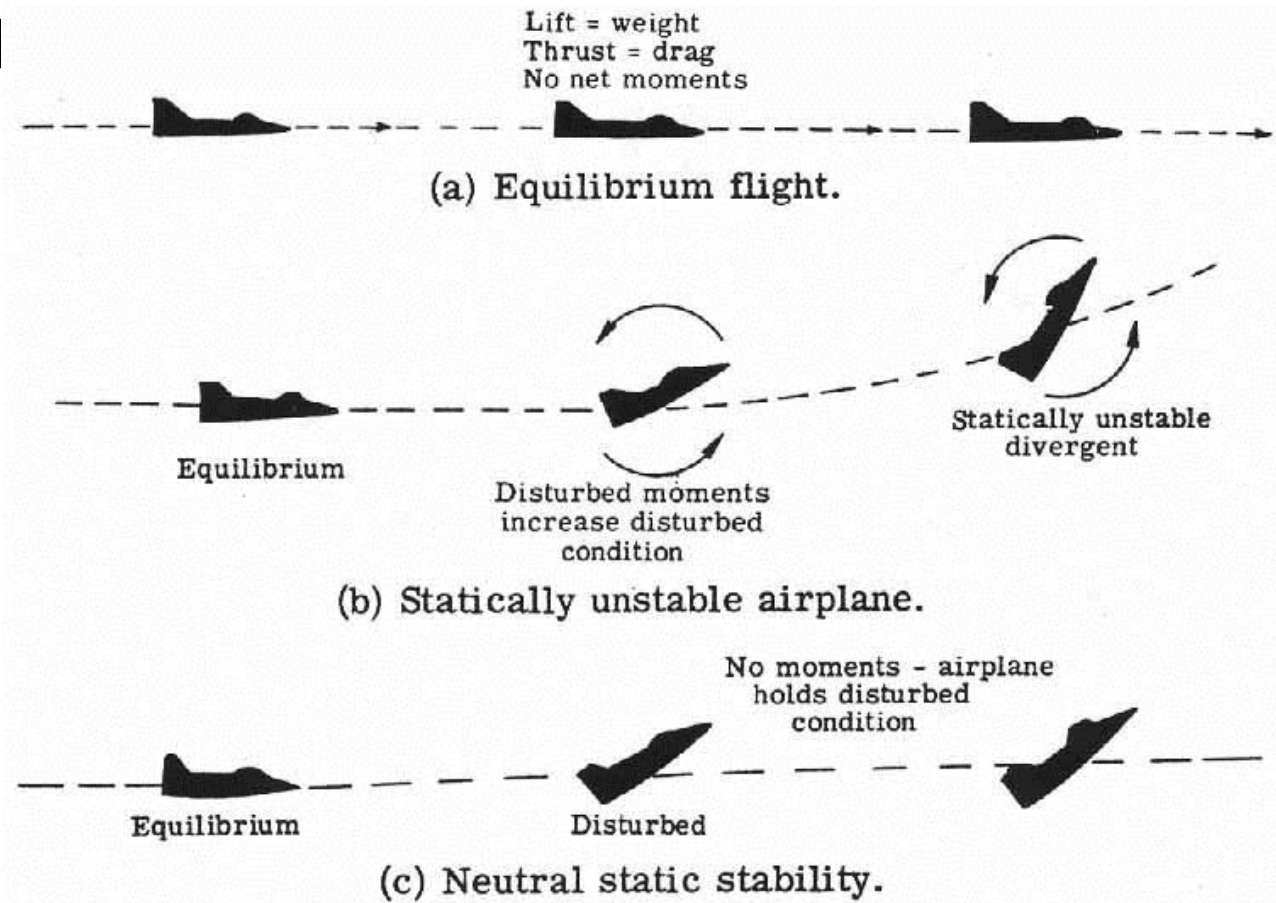

Aerodynamics-Stability

- Dynamic Stability:

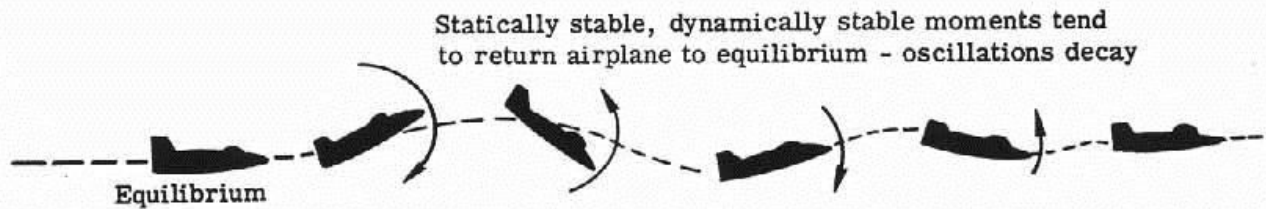

(a) Statically and dynamically stable.

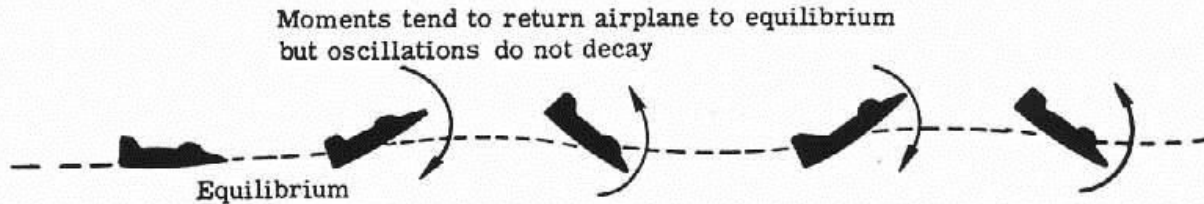

(b) Statically stable; neutral dynamic stability.

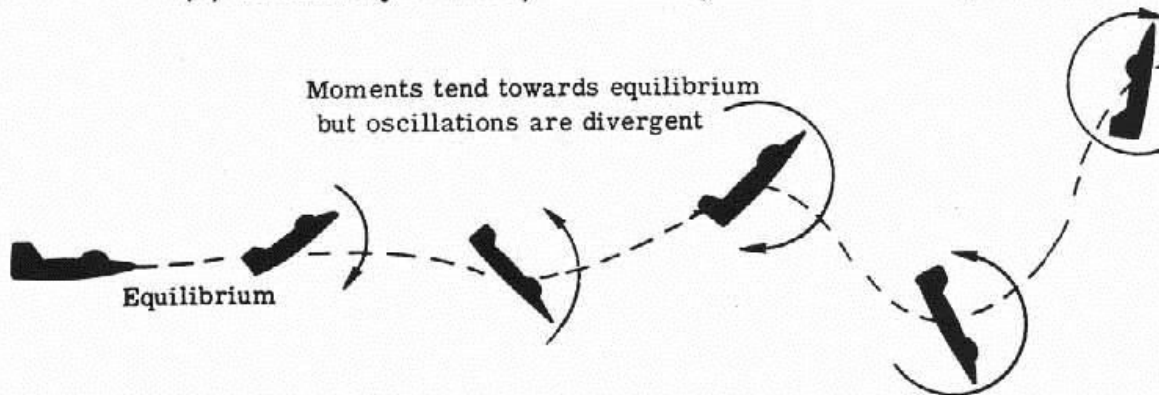

(c) Statically stable; dynamically unstable.

Aerodynamics-Sta

http://www.youtube.com/watch?v=kh_I25FmOrl

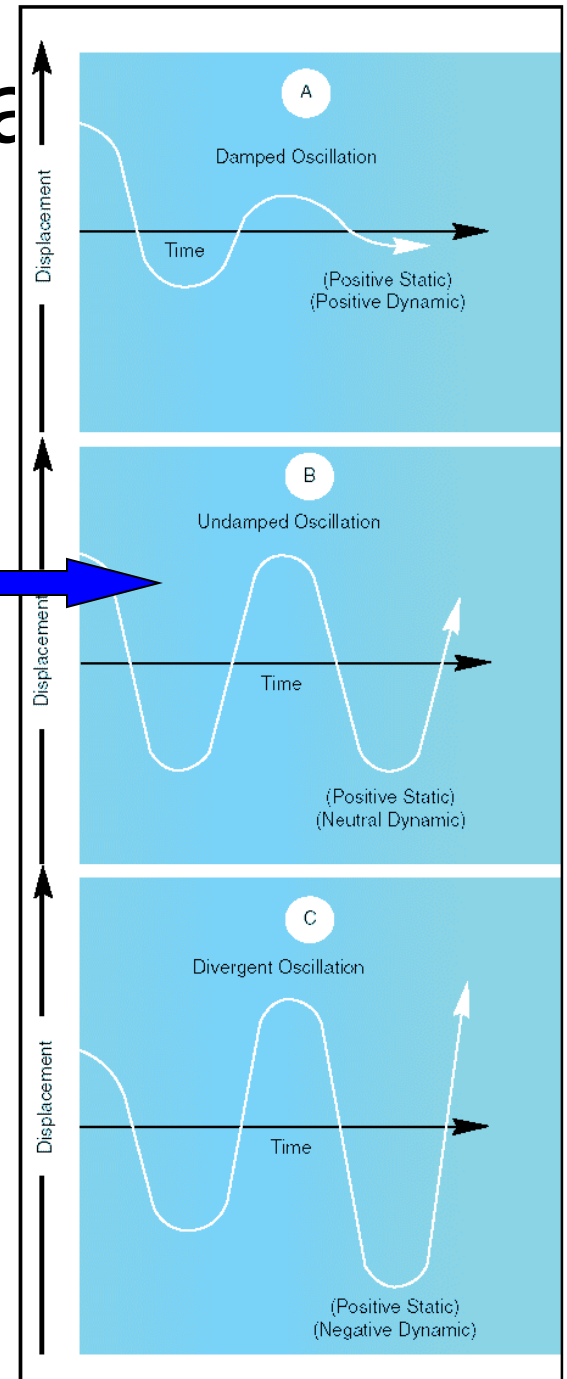

Aerodynamics-Stability

- Dihedral- This is the angle that exists between the wings and the fuselage. Dihedral affects longitudinal stability
- Yaw stability-developed from the vertical stabilizer

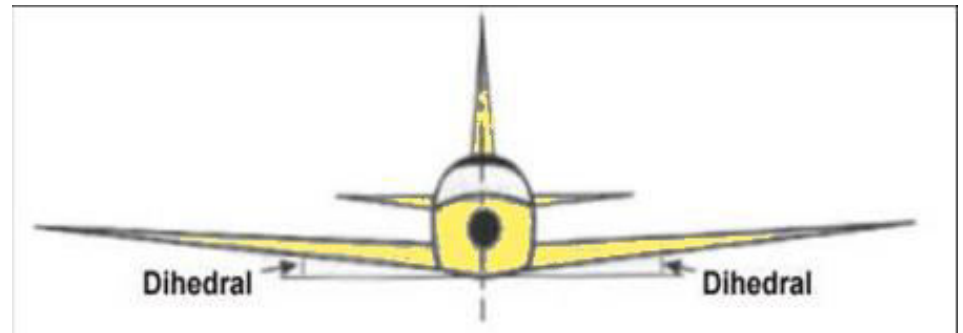

UNIT-4

SATELLITE SYSTEM ENGINEERING

Space Mission Types(unmanned and manned)

Unmanned Missions:

- Earth orbiters
- Planetary and lunar explorers

Earth orbiters

COMSATS(Communication satellites)

1. International
2. Domestic
3. Direct broadcast
4. Military

Earth Orbiter



- Weather
- Earth observers
- Navigation
- Astronomy
- Space physics

Military

- Surveillance
- Early warnings
- Nuclear detections
- Intelligence
- Antisatellite

Planetary and lunar explorers

Fly-bys

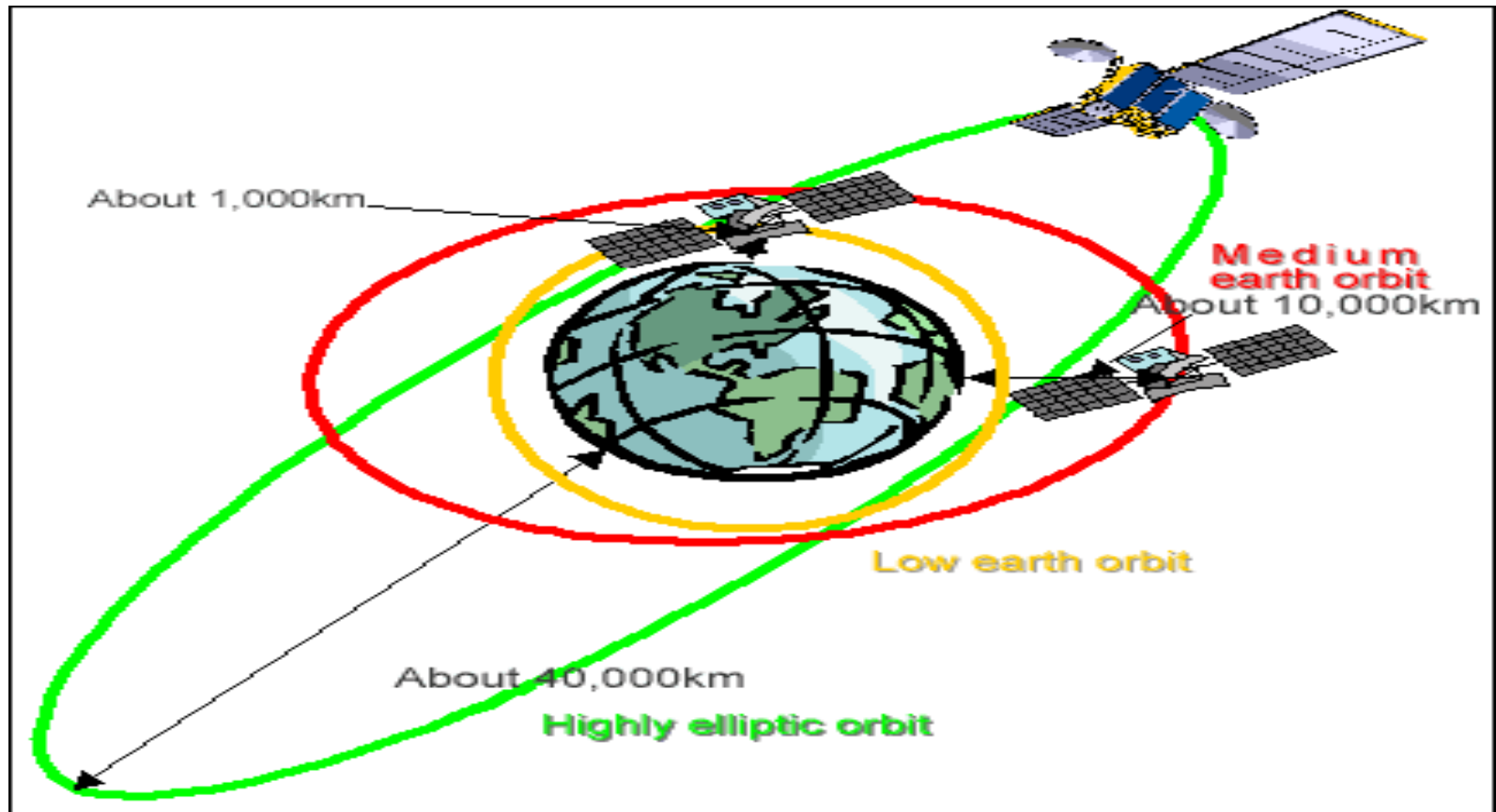

Probes

A blunt-ended instrument used for study, analysis or research a part of the body.



Orbiters

A spacecraft designed to go into orbit, especially one that does not subsequently land .



Landers

A spacecraft designed to land on the surface of a planet or moon.



Rovers

A craft who spends their time wandering.



Manned machines

Orbiters

A spacecraft designed to go into orbit, especially one that does not subsequently land .



Lunar orbits



Stations

A **space station**, also known as an **orbital station** or an **orbital space station**, is a [spacecraft](#) capable of supporting a crew, which is designed to remain in [space](#) (most commonly in [low Earth orbit](#)) for an extended period of time and for other spacecraft to dock

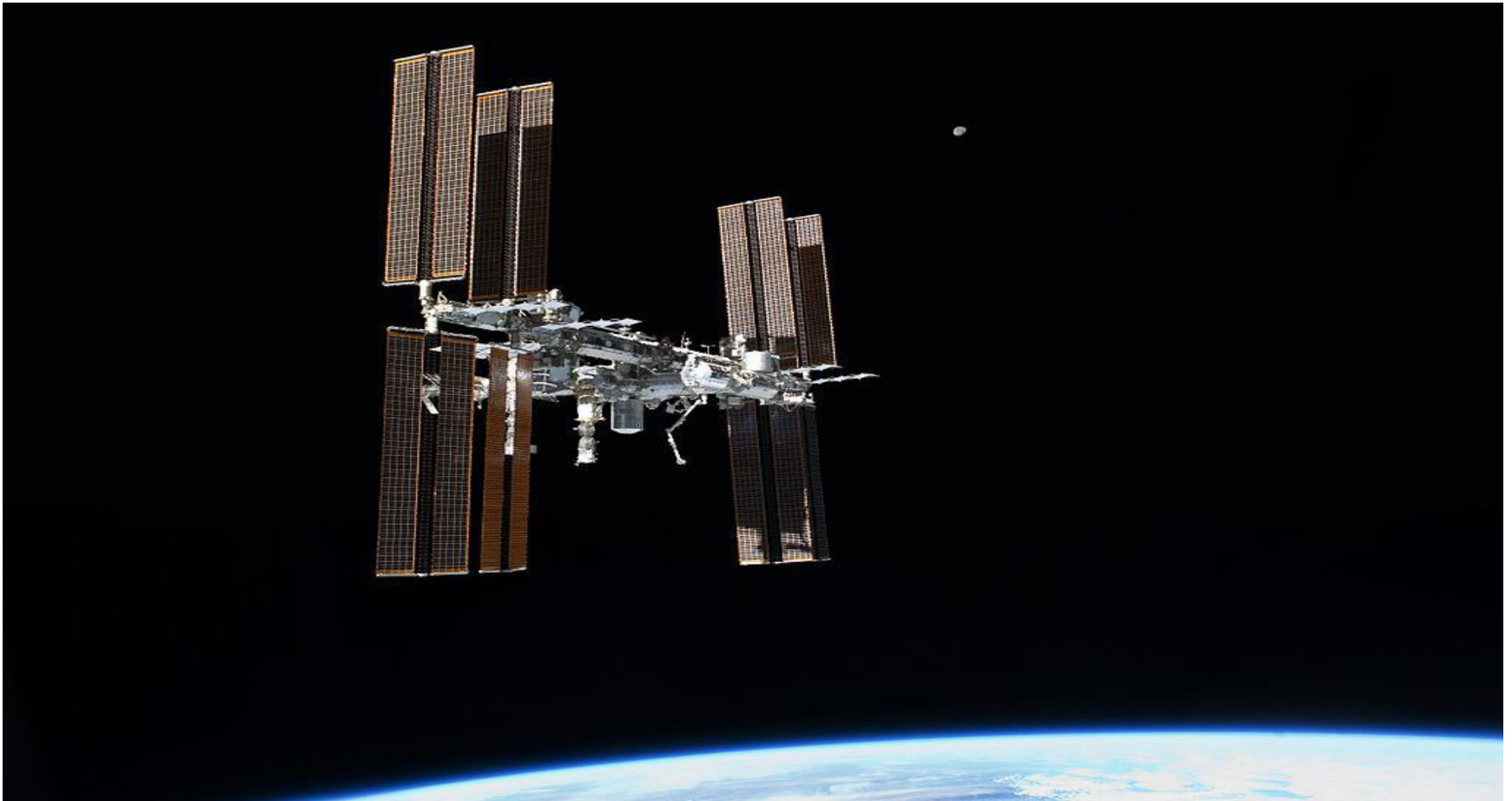

Space Environment

Earth environment

Atmosphere layers

- **Troposphere**(5-16Km)75% of all the air which forms clouds and rain
- **Stratosphere**(Extends up to 50Km) Ozone in the Atmosphere and absorption of UV Radiation From the sun
- **Mesosphere**(-90c Temp decreases with height)
- **Thermosphere & Ionosphere**(Temp increases with height Due to absorption of energetic ultraviolet and x-ray radiation from the sun)
- **Exosphere**(Region above 500km)contains mainly oxygen and hydrogen atoms
- **Magnetosphere**(like huge magnet it traps electrons(-ve) and protons(+ve) concentrating them in two bands about 3000km and 16000km above the globe called 'Radiation belts')

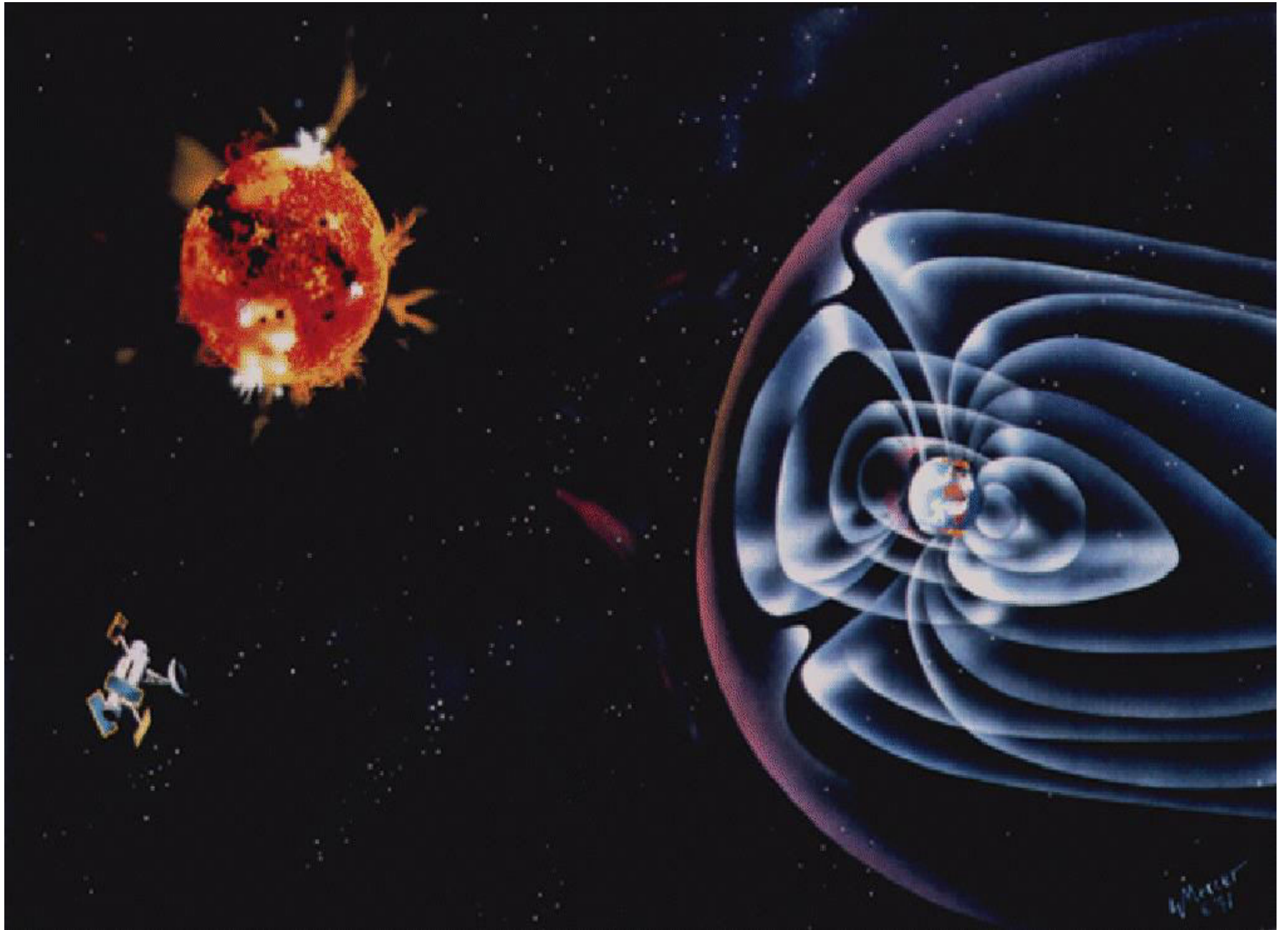

Launch Environment

Before launch

- Axial loads by the accelerating launch vehicles
- Lateral loads from steering and wind gust

After liftoff

- Rocket engine noise
- Aerodynamic noise

In desired orbit or Trajectory

- Acoustic, vibrations, and shock levels

Launch Vehicle Selection

1. LEO (Low Earth Orbit)

2. GEO (Geo-stationary Earth Orbit)

3. HEO (High Earth Orbit)

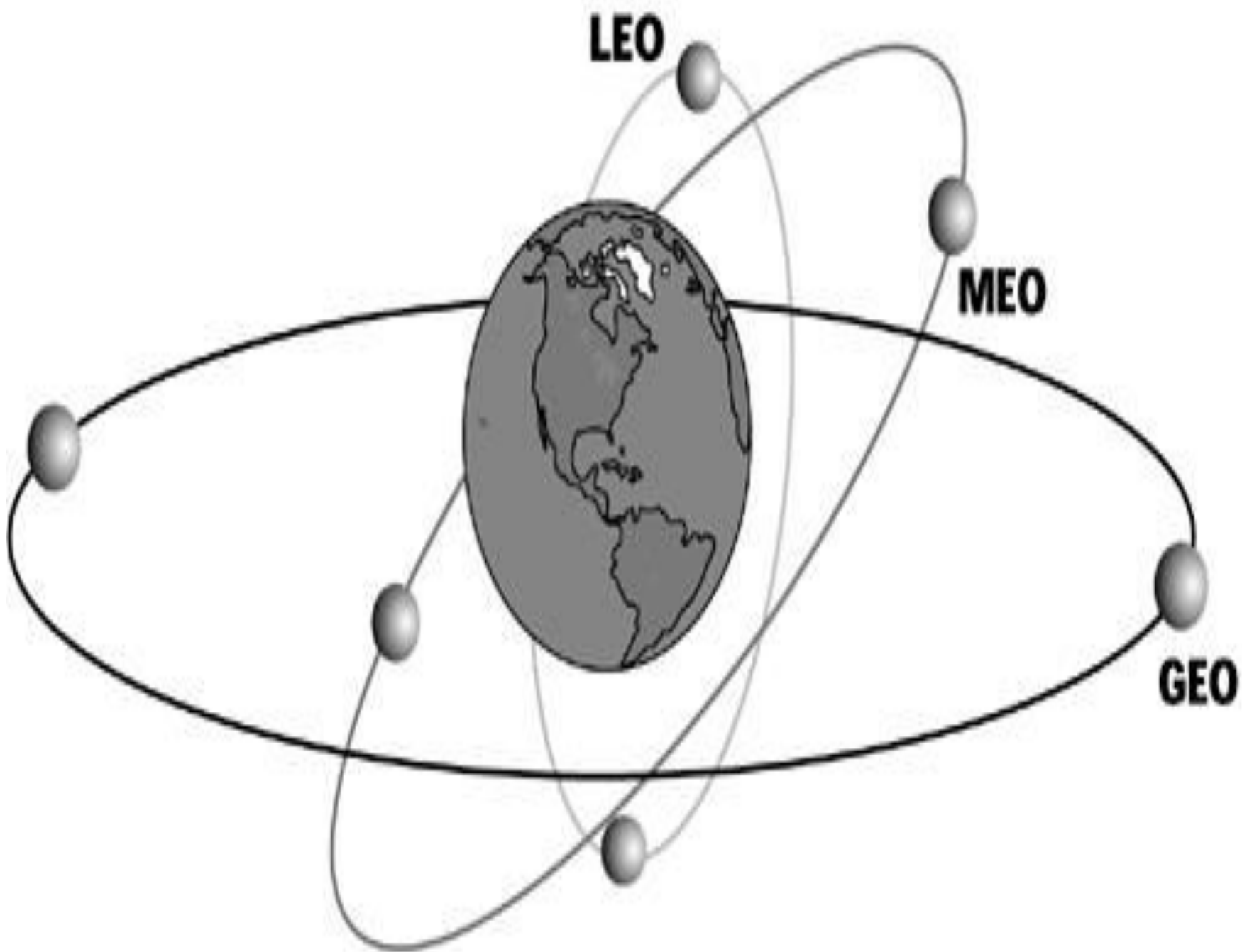

Communications and telemetry

- Attitude Determination and Control Subsystem (ADCS)
 - Stabilizes the vehicle
 - Orients vehicle in desired directions
 - Senses the orientation of the vehicle relative to reference (e.g. inertial) points
- Determination: Sensors
- Control: Actuators
- Controls attitude despite external disturbance torques acting on spacecraft

Power systems

- ADCS Design Requirements and Constraints
 - Pointing Accuracy (Knowledge vs. Control)
 - Drives Sensor Accuracy Required
 - Drives Actuator Accuracy Required
 - Rate Requirements (e.g. Slew)
 - Stationkeeping Requirements
 - Disturbing Environment
 - Mass and Volume
 - Power
 - Reliability
 - Cost and Schedule

Gravity Gradient Stabilization

- Deploy gravity gradient boom
- Coarse roll and pitch control
- No yaw control
- Nadir pointing surface
- Limited to near Earth satellites

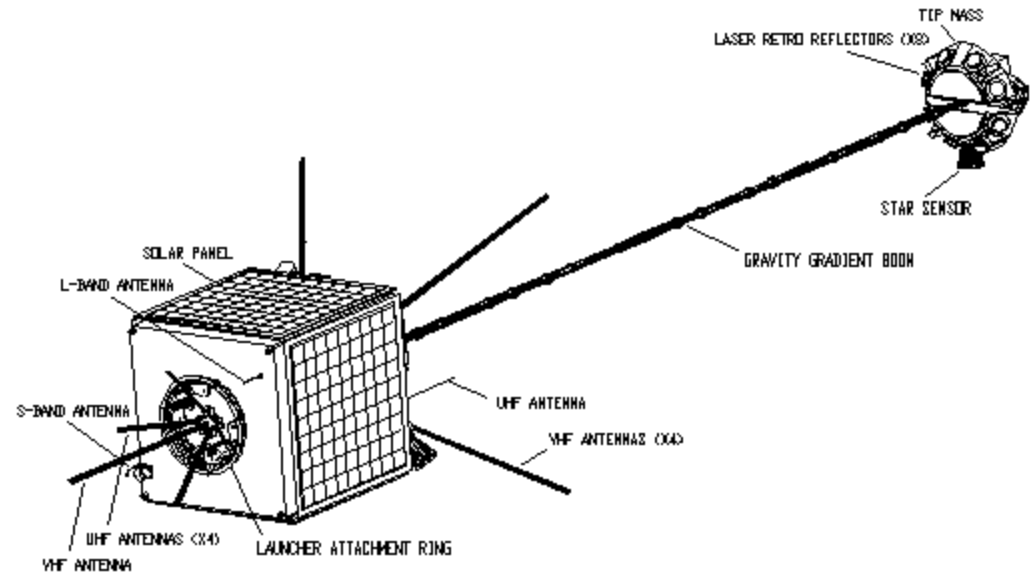

Best to design such that $I_{pitch} > I_{roll} > I_{yaw}$

Spin Stabilization

- Entire spacecraft rotates about vertical axis
- Spinning sensors and payloads
- Cylindrical geometry and solar arrays

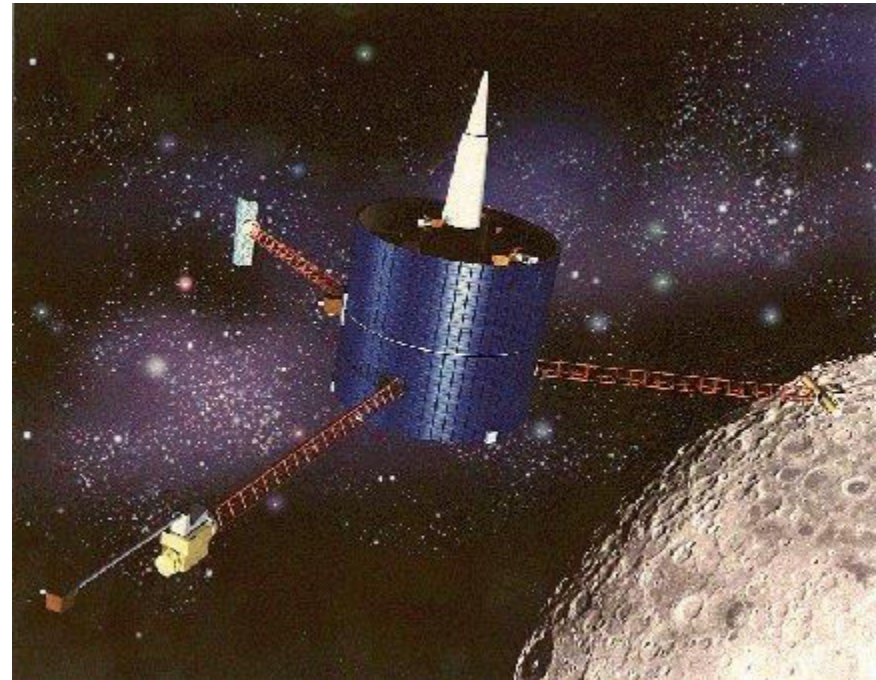

Spin Stability

UNSTABLE

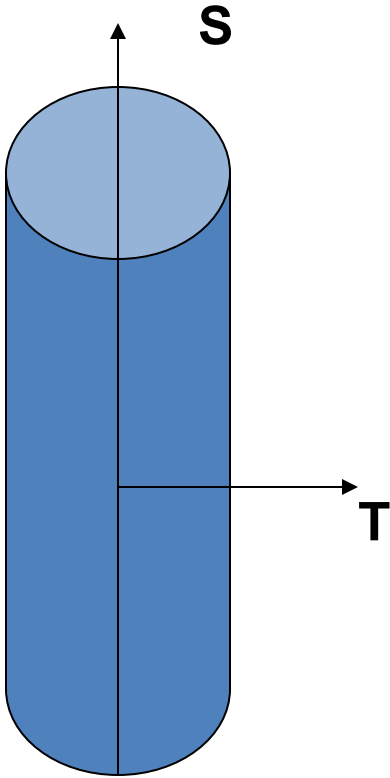

$$\frac{I_S}{I_T} < 1$$

STABLE

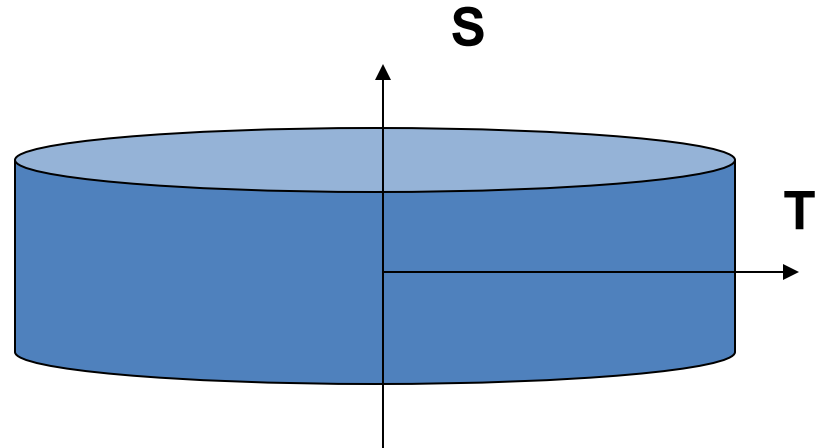

$$\frac{I_S}{I_T} > 1$$

3-Axis Stabilization

- Active stabilization of all three axes
 - Thrusters
 - Momentum (Reaction) Wheels
 - Momentum dumping
- Advantages
 - No de-spin required for payloads
 - Accurate pointing
- Disadvantages
 - Complex
 - Added mass



Attitude Determination

- Earth Sensor (horizon sensor)
 - Use IR to detect boundary between deep space & upper atmosphere
 - Typically scanning (can also be an actuator)
- Sun Sensor
- Star Sensor
 - Scanner: for spinning S/C or on a rotating mount
 - Tracker/Mapper: for 3-axis stabilized S/C
 - Tracker (one star) / Mapper (multiple stars)
- Inertial Measurement Unit (IMU)
 - Rate Gyros (may also include accelerometers)
- Magnetometer
 - Requires magnetic field model stored in computer
- Differential GPS

Attitude Determination

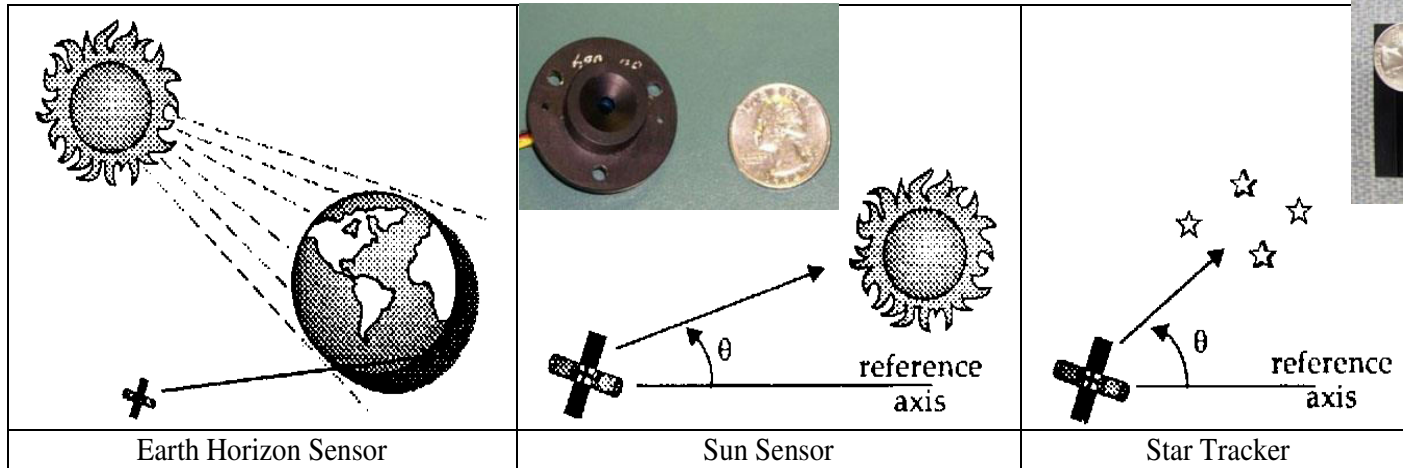

Sensor	Accuracies	Comments
IMU	Drift: 0.0003 – 1 deg/hr 0.001 deg/hr nominal	Requires updates
Star Sensor	1 arcsec – 1 arcmin (0.0003 – 0.001 deg)	2-axis for single star Multiple stars for map
Sun Sensor	0.005 – 3 deg 0.01 deg nominal	Eclipse
Earth Sensor GEO LEO	< 0.1 – 0.25 deg 0.1 – 1 deg	2-axis
Magnetometer	0.5 – 3 deg	< 6000 km Difficult for high i

Mission phases and core operations

Team Responsibilities

- Mission concepts Development phase
- Mission requirement and design phase
- Flight and Ground system development phase
- Integration and Environmental testing

CASE STUDIES

- Concept of mission operation
- Configuration management
- Application of flight constraints
- Training and certification
- Real time operations
- Documentation
- Contingency planning
- Spacecraft performance Assessment

Objectives

- Spacecraft orbit(LEO, GEO, HEO, deep space)
- Mission sponsor and payload type (3-axis,spin,gravity gradient)
- Spacecraft attitude control
approach(NASA,DOD,COMMERCIAL)

UNIT-5

Basics of Flight Mechanics

Mach waves

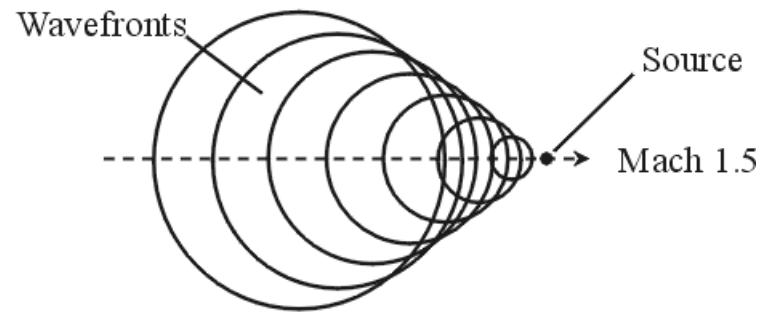
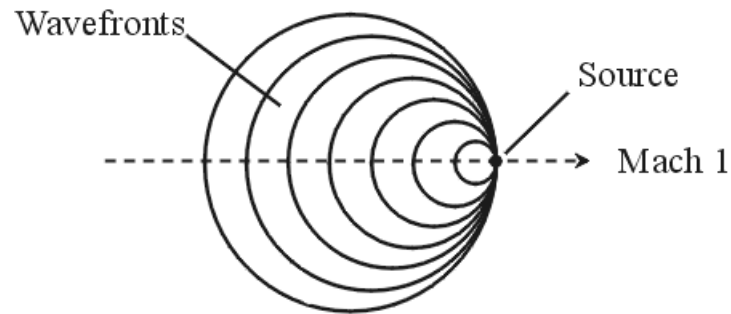
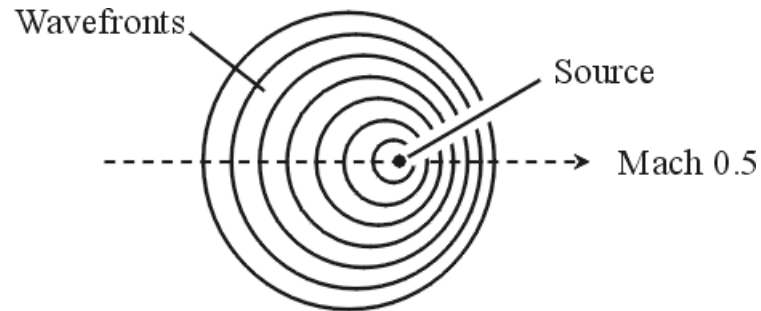

mach

Stability

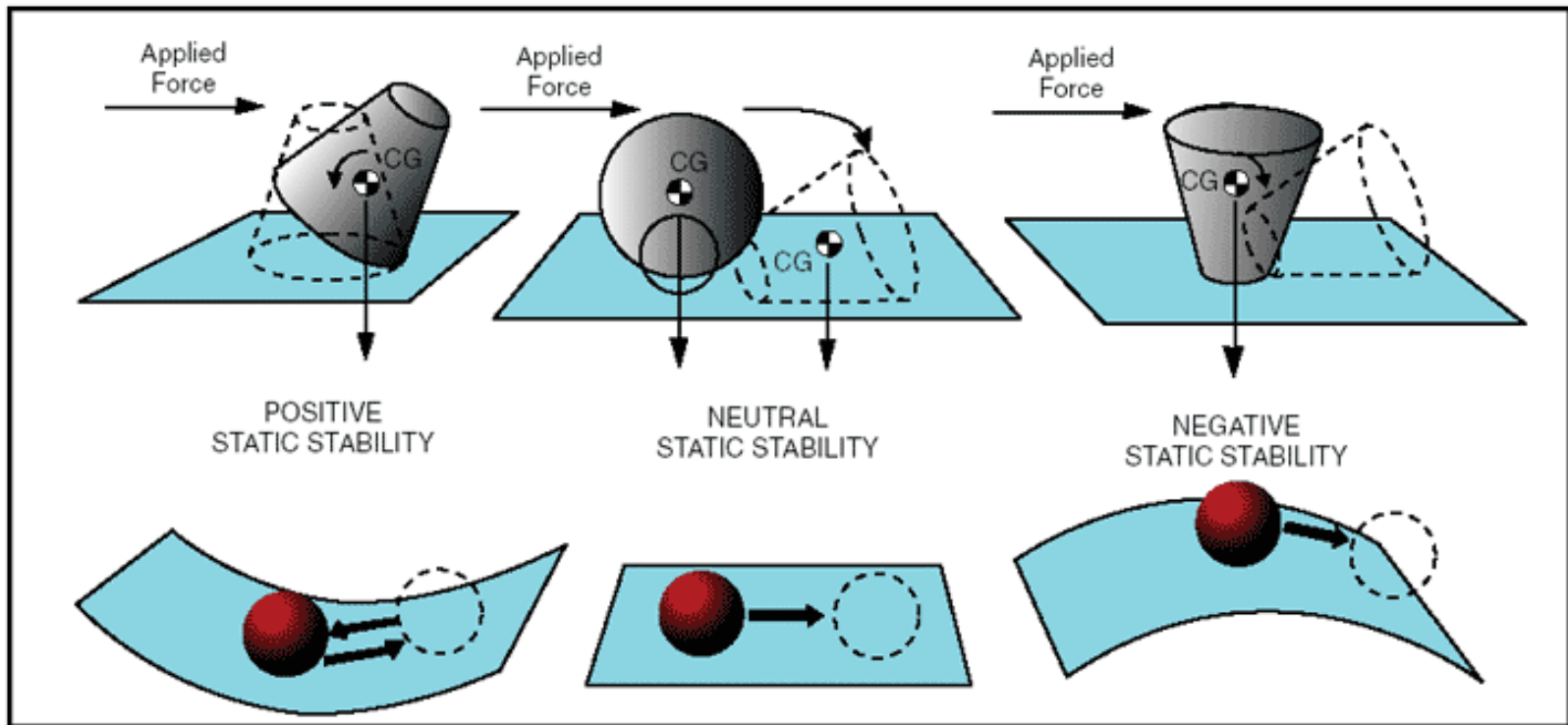

Different types of flaps



Plain



Split



Single-Slotted



Double-Slotted

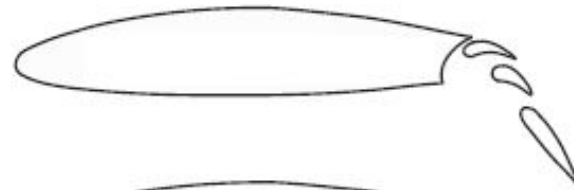

Triple-Slotted



Fowler



Double-Slotted Fowler

Effect of flaps on lift-coefficient

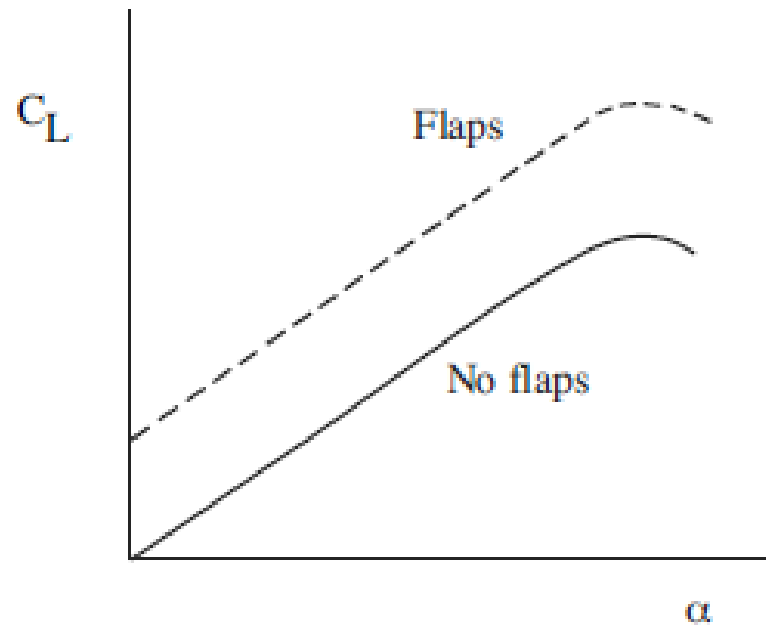

Forces in Turns

Level Flight

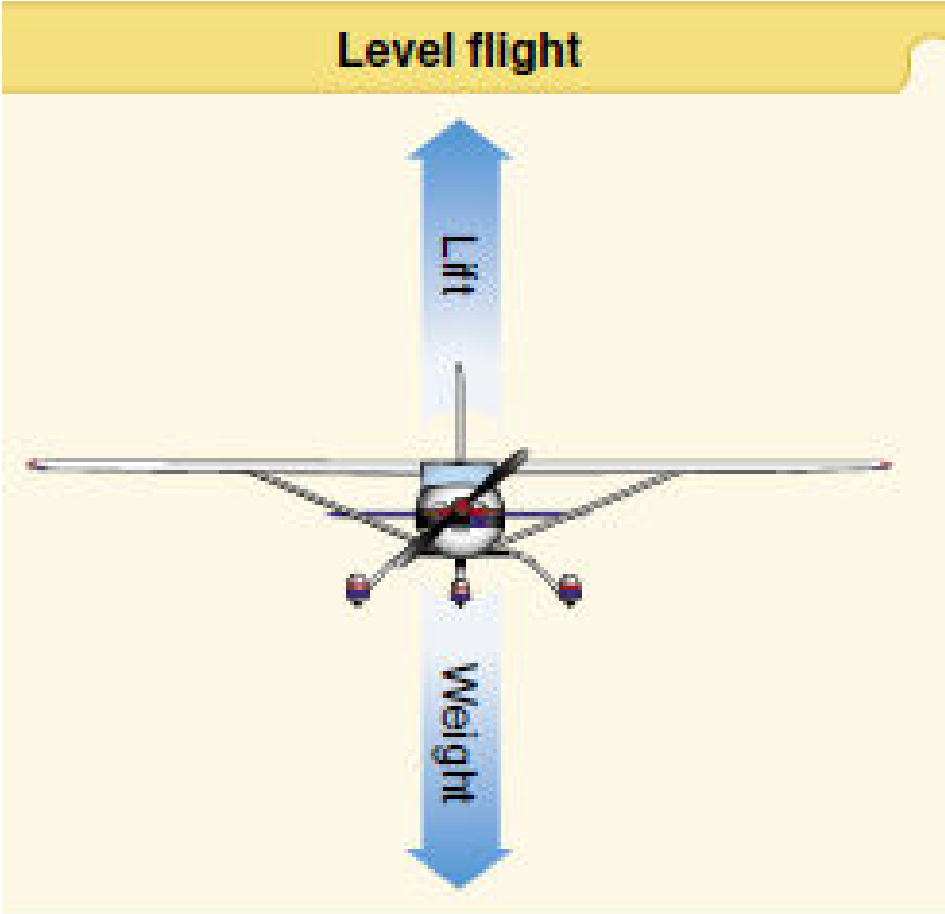

Medium Banked Turn

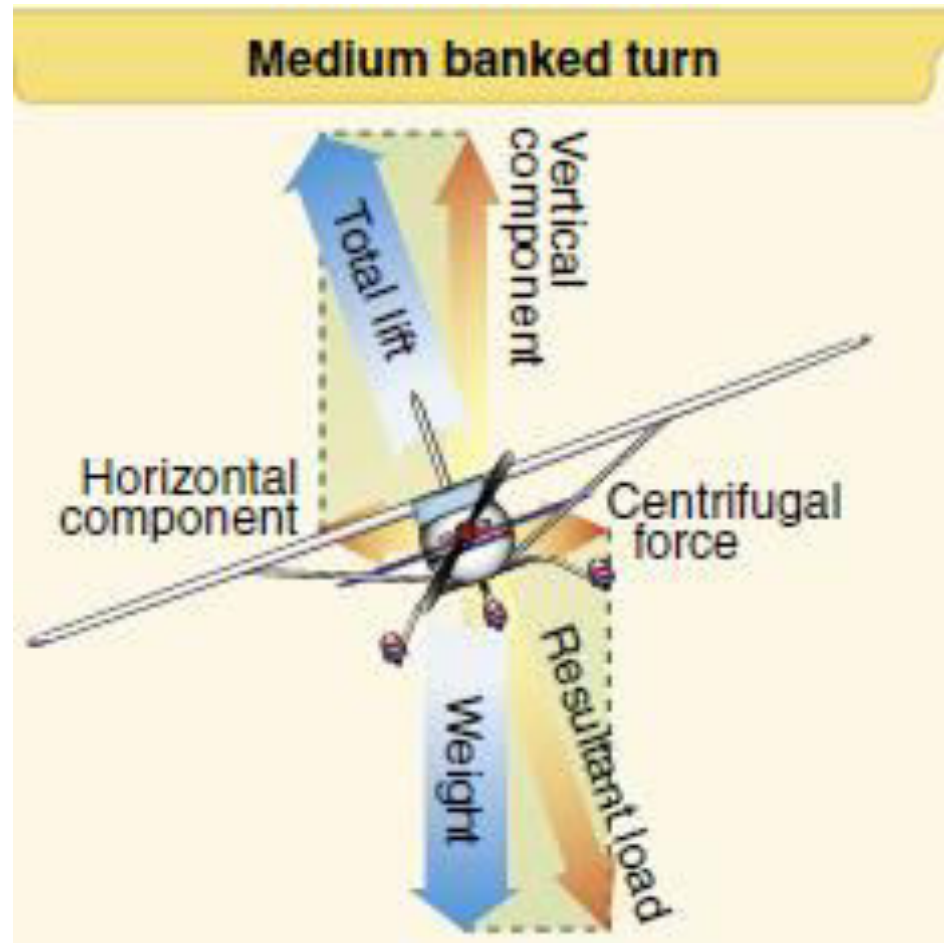

Steeply Banked Turn

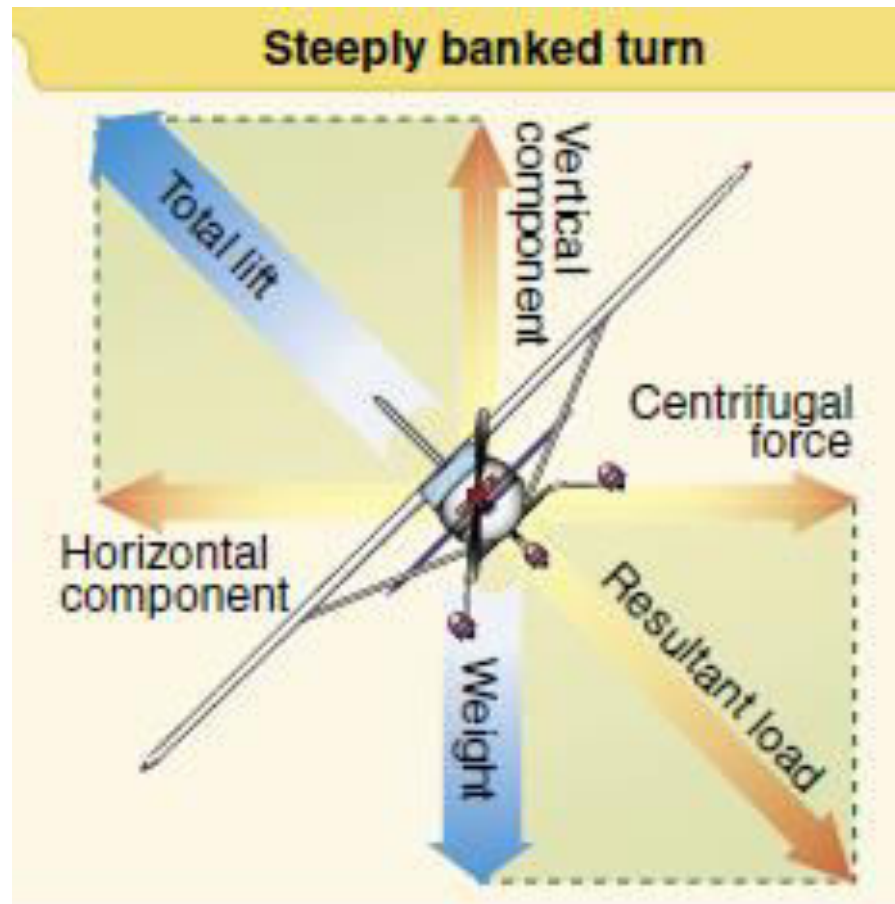

Normal Turn

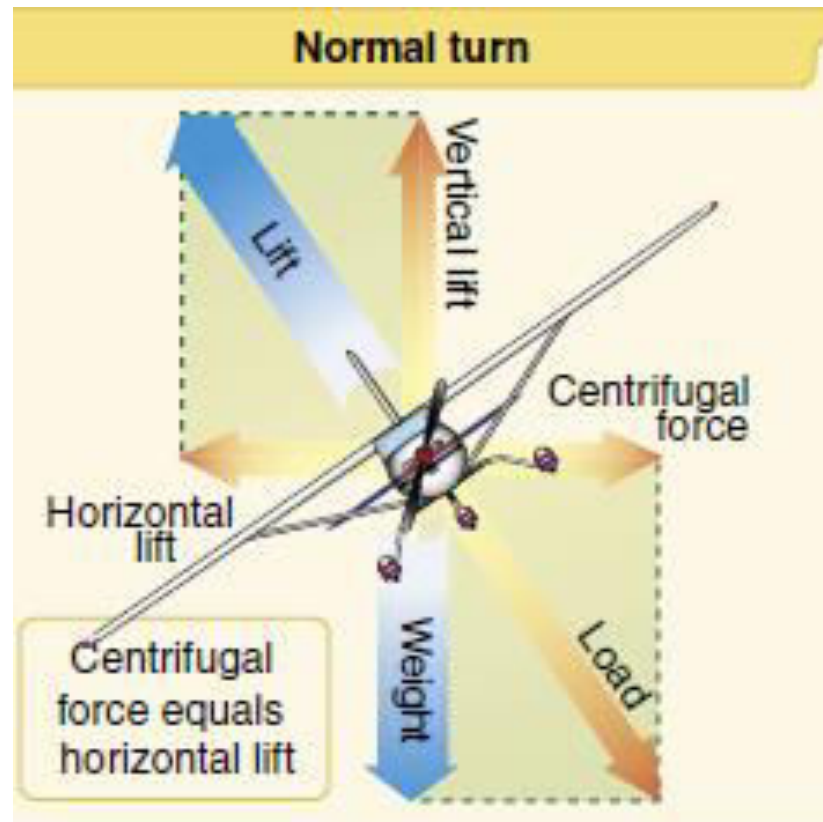

Slipping Turn

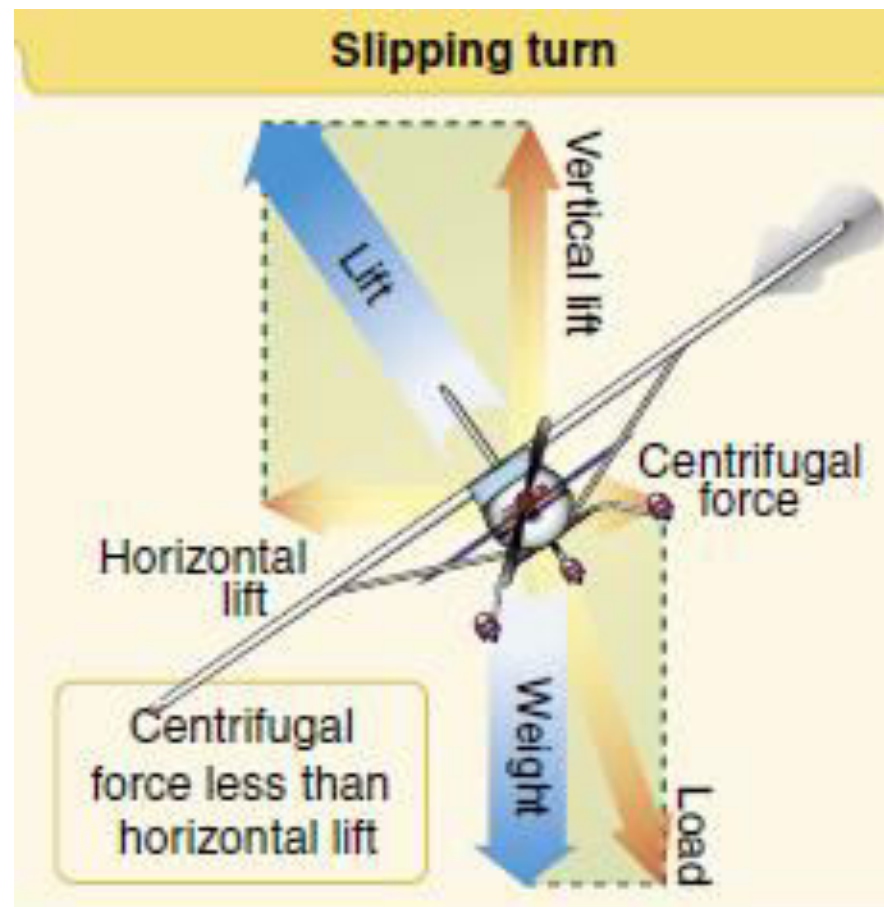

Skidding Turn

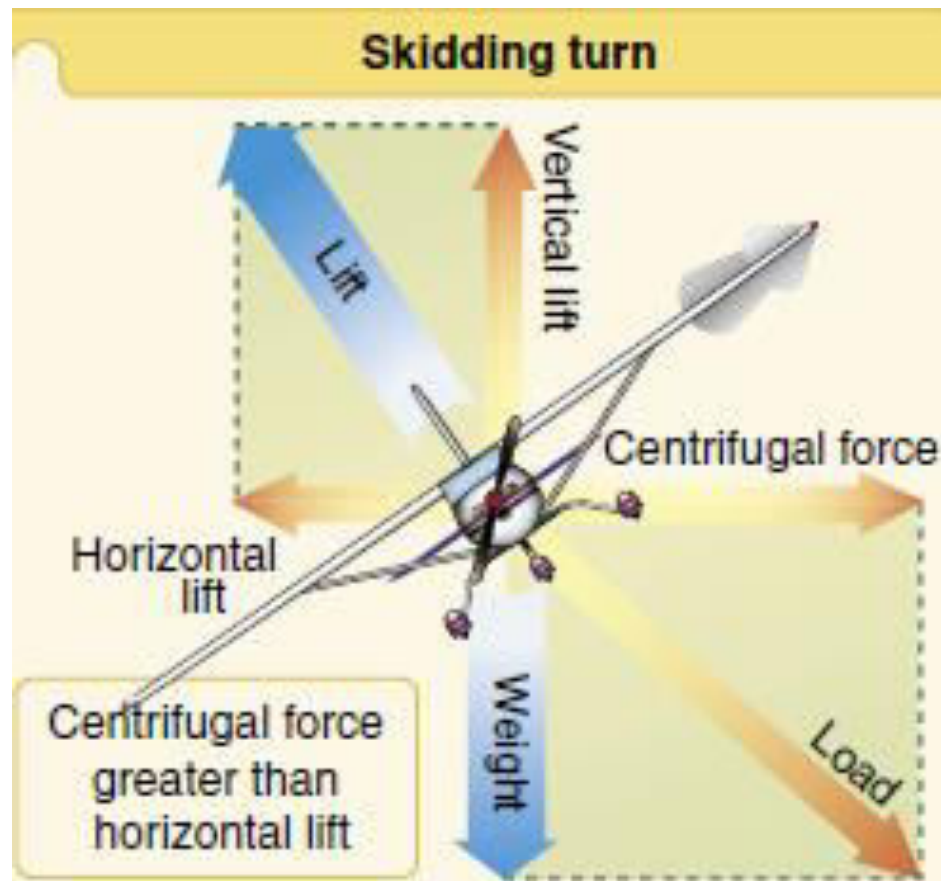

Shock waves

- Shock waves are compression waves
- The properties of the flow changes rapidly after the shock formation

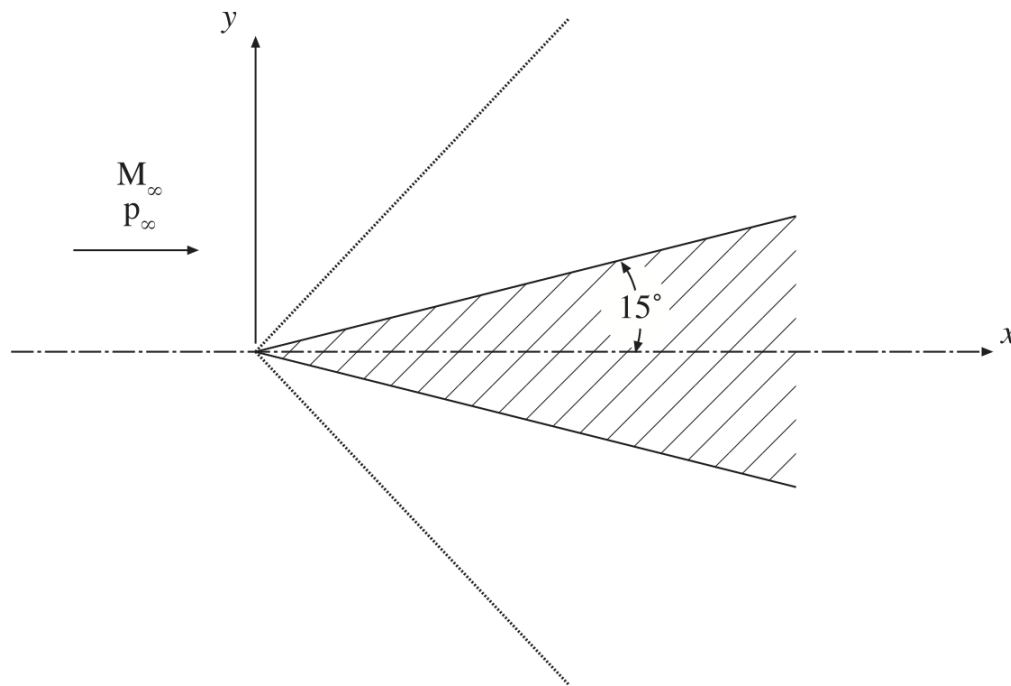

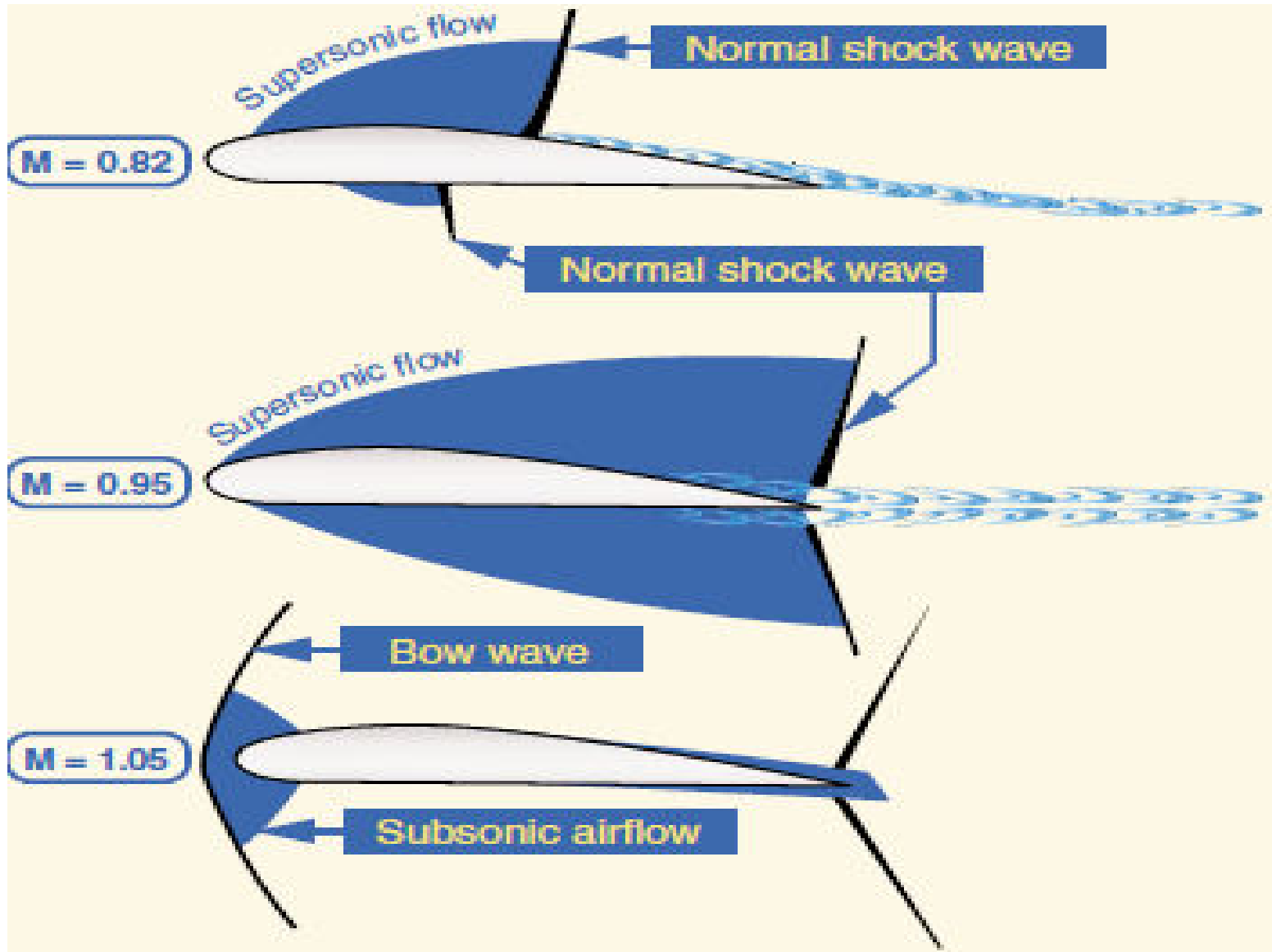

Load Factor

It is the maximum load an aircraft can sustain to the gross weight of the aircraft

- The load factor is measured in G's (Acceleration due to gravity)**

Load Factor in steep turns

